



DAG1000-8S VoIP Gateway User Manual V3.0



Dinstar Technologies Co., Ltd.

Address: 9th Floor, Guoxing Building, Changxing Road, Nanshan District, Shenzhen, China

Postal Code: 518052

Telephone: +86 755 61919966

Fax: +86 755 2645 6659

Emails: sales@dinstar.com, support@dinstar.com

Website: www.dinstar.com

Revision Record

| | |
|------------------|-------------------------------------|
| File Name | DAG1000-8S VoIP Gateway User Manual |
| Document Version | V3.0 |
| Firmware Version | 2.18.10.05 |
| Date | 2022/05/31 |
| Revised by | Technical Support Department |

Preface

Welcome

Thanks for choosing **DAG1000-8S VoIP Gateway**! We hope you will make optimum use of this flexible, rich-feature VoIP-to-FXS gateway. Please read this document carefully before install the gateway.

About this manual

This manual provides information about the introduction of the gateway, and about how to install, configure or use the gateway.

For interoperability with different IPPBX/Softswitch platform, you can refer to relevant configuration guide of different systems.

This manual is written with reference to the default configurations of the **DAG1000-8S** VoIP Gateway.

Intended audience

This manual is aimed primarily at network and system engineers who will install, configure and maintain the gateway.

System engineers are persons who customize the configurations to meet the requirements of users.

Parts of the document containing description of telephony features are aimed at users who are the persons who will actually use the gateway.

Contents

| | |
|--|-----------|
| 1 Introduction of DAG1000-8S | 1 |
| 1.1 Overview | 1 |
| 1.2 Equipment Appearance..... | 2 |
| 1.3 Ports and Connectors..... | 2 |
| 1.4 Functions and Features | 3 |
| 1.4.1 Protocol standard supported | 3 |
| 1.4.2 Voice and Fax parameters..... | 4 |
| 1.4.3 Supplementary service..... | 4 |
| 2 Basic Operations..... | 5 |
| 2.1 Methods to Number Dialing..... | 5 |
| 2.2 Direct IP Calls..... | 5 |
| 2.3 Call Holding | 6 |
| 2.4 Call Waiting | 6 |
| 2.5 Call Transfer | 6 |
| 2.5.1 Blind Transfer | 6 |
| 2.5.2 Attended Transfer | 6 |
| 2.6 Three-way Calling..... | 7 |
| 2.7 Description of Feature Codes..... | 7 |
| 2.8 Sending and Receiving Fax | 9 |
| 2.8.1 T. 38 and Pass-Through | 9 |
| 2.9 Local IVR Operation..... | 9 |
| 2.9.1 Inquire IP address..... | 9 |
| 2.9.2 Factory Reset..... | 9 |
| 2.9.3 Configure LAN Port's IP Address | 9 |
| 3 Configurations on Web Interface | 11 |
| 3.1 Network Connection | 11 |
| 3.2 Preparations for Login..... | 11 |
| 3.3 Log in Web Interface | 12 |
| 3.4 Navigation Tree | 13 |
| 3.5 State and Statistics | 14 |

| | |
|---|----|
| 3.5.1 System Information..... | 14 |
| 3.5.2 Registration Information..... | 16 |
| 3.5.3 TCP/UDP Statistics..... | 17 |
| 3.5.4 RTP Session Statistics | 17 |
| 3.5.5 CDR Statistics..... | 17 |
| 3.6 Quick Setup Wizard | 18 |
| 3.7 Network Configuration..... | 18 |
| 3.7.1 Local Network | 18 |
| 3.7.2 VLAN (Virtual Local Area Network) | 20 |
| 3.7.3 DHCP Server (Route Mode)..... | 21 |
| 3.7.4 DMZ Host (Route Mode) | 22 |
| 3.7.5 Forward Rule (Route Mode)..... | 23 |
| 3.7.6 Static Route (Route Mode)..... | 23 |
| 3.7.7 ARP | 24 |
| 3.8 SIP Server..... | 24 |
| 3.9 Port..... | 27 |
| 3.10 Advanced..... | 29 |
| 3.10.1 FXS/FXO Parameters | 29 |
| 3.10.2 Media Parameter | 31 |
| 3.10.3 SIP Parameters | 33 |
| 3.10.4 Fax Parameter | 38 |
| 3.10.5 Digit Map..... | 39 |
| 3.10.6 Feature Codes | 40 |
| 3.10.7 System Parameter | 41 |
| 3.10.8 Action URL | 43 |
| 3.11 Call & Routing..... | 44 |
| 3.11.1 Wildcard Group | 44 |
| 3.11.2 Port Group..... | 44 |
| 3.11.3 IP Trunk | 46 |
| 3.11.4 Routing Parameter | 47 |
| 3.11.5 IP -> Tel Routing | 48 |
| 3.11.6 Tel-IP/Tel Routing..... | 49 |
| 3.11.7 IP – IP Routing | 50 |

| | |
|--|-----------|
| 3.12 Manipulation Configuration | 50 |
| 3.12.1 IP -> Tel Callee | 51 |
| 3.12.2 Tel -> IP/Tel Caller | 52 |
| 3.12.3 Tel-IP/Tel Callee | 53 |
| 3.13 Routing rule examples..... | 53 |
| 3.13.1 Route any calls from any IP to specific port | 53 |
| 3.13.2 Route any calls from any IP to specified port group | 54 |
| 3.13.3 Route any calls from any port to specific SIP IP trunk..... | 55 |
| 3.14 Maintenance | 57 |
| 3.14.1 TR069..... | 57 |
| 3.14.2 SNMP | 57 |
| 3.14.3 Syslog..... | 59 |
| 3.14.4 Provision..... | 61 |
| 3.14.5 Cloud server | 62 |
| 3.15 Security..... | 62 |
| 3.15.1 WEB ACL | 62 |
| 3.15.2 Telnet ACL | 63 |
| 3.15.3 Passwords..... | 63 |
| 3.16 Tools | 64 |
| 3.16.1 Firmware upload | 64 |
| 3.16.2 Data Backup | 66 |
| 3.16.3 Data Restore..... | 66 |
| 3.16.4 Ping Test | 66 |
| 3.16.5 Tracert Test | 67 |
| 3.16.6 Outward Test..... | 68 |
| 3.16.7 Network Capture..... | 69 |
| 3.16.8 Factory Reset..... | 73 |
| 3.16.9 Device Restart | 74 |
| 4 Glossary | 75 |

1 Introduction of DAG1000-8S

1.1 Overview

DAG1000-8S VoIP gateway provides voice services based on IP network. It's a cost-effective and flexible solution for SOHO (Small Office-Home office), remote office, medium-sized enterprise and enterprise with multiple branches.

The gateway connects to analog telephone, fax and traditional analog PBX with standard voice interfaces and provides high quality voice service.

The gateway, based on standard SIP protocol is compatible with leading IP PBX, soft-switch and SIP-based platform.

The FXS analog gateway available in the following configurations:

| Model | Voice Channels | FXS Ports | Physical Port Labels |
|------------|----------------|-----------|----------------------|
| DAG1000-8S | 8 | 8 | 0-7 |

For detailed hardware and software features, please refer to "product specifications".

1.2 Application Scenario

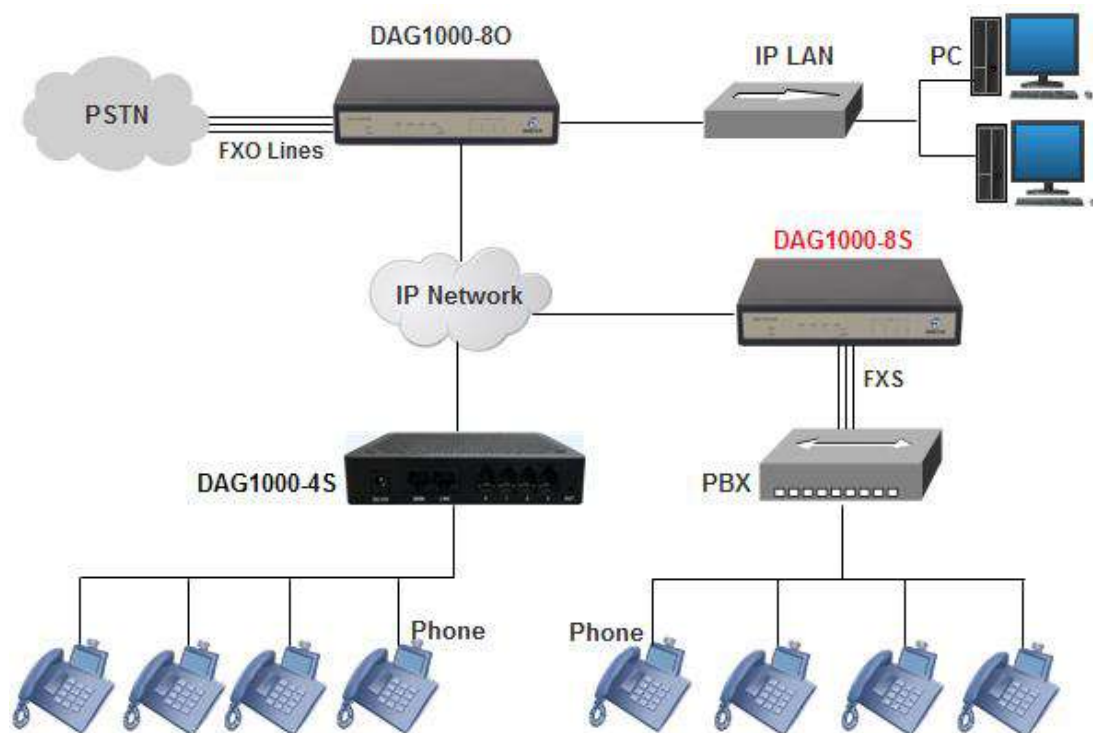

1.3 Equipment Appearance



Front View



Back View

1.4 Ports and Connectors

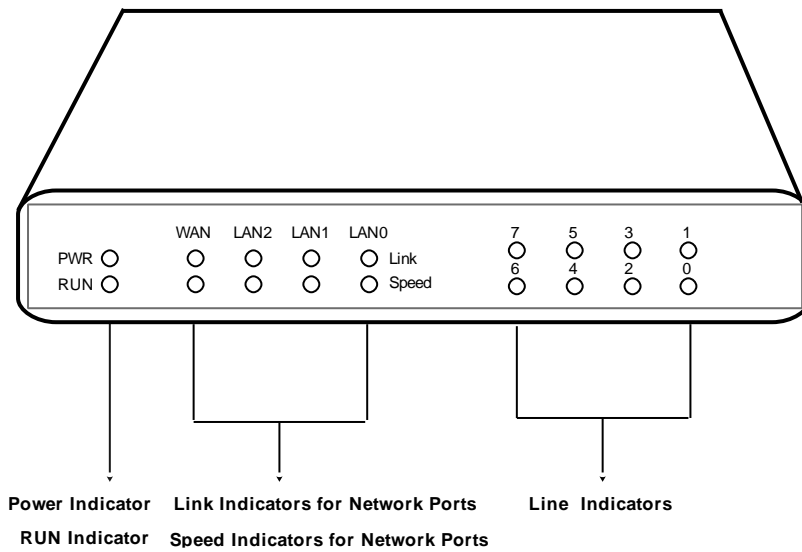

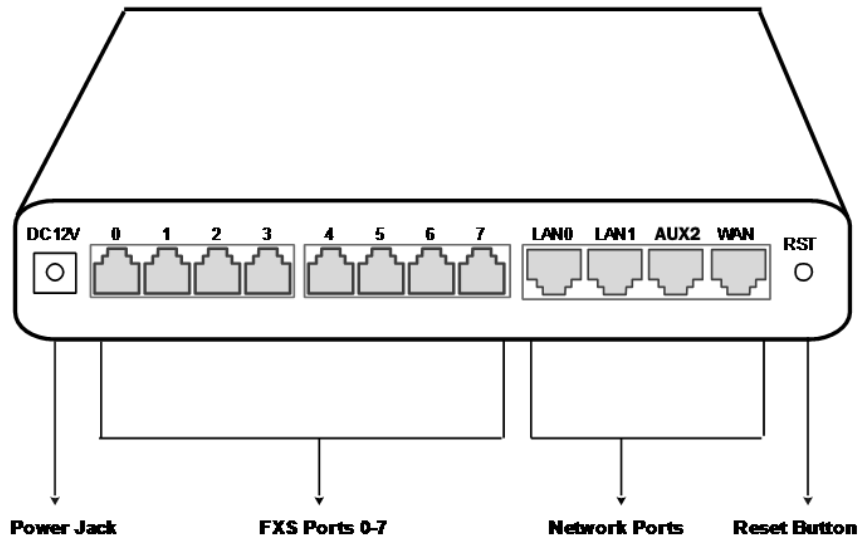

| Port Name | Connector | Description |
|---------------|------------|---|
| Power Jack | Power Jack | To connect DC 12V power supply |
| WAN/LAN Port | RJ45 | to connect to the IP network over a DSL modem or Router or a LAN switch |
| FXS Ports 0-7 | RJ11 | FXS ports to connect standard analog phone or FAX machine or a PBX |

1.5 Functions and Features

1.5.1 Protocol standard supported

- SIP V2.0 (RFC 3261,3262,3264)
- SDP (RFC2327)
- REFER (RFC 3515)
- RTP/RTCP (RFC 1889,1890)
- STUN (RFC 3489)
- ARP/RARP (RFC 826/903)
- SNTP (RFC 2030)
- DHCP/PPPoE
- TFTP/HTTP/HTTPS

- DNS/DNS SRV (RFC 1706/RFC 2782)
- VLAN 802.1P/802.1Q

1.5.2 Voice and Fax parameters

- G.711A/U law, G.723.1, G.729AB, iLBC, AMR
- Comfortable Noise Generation (CNG)
- Voice Activity Detection (VAD)
- Echo Cancellation (G.168)
- Adaptive Dynamic Jitter Buffer
- Voice and fax gain control
- Modem
- T.38/Pass-through
- DTMF Mode: Signal/RFC2833/INBAND

1.5.3 Supplementary service

- Call waiting
- Call transfer (Blind transfer, Attend transfer)
- Quick pick
- Call Forwarding Unconditional
- Call Forwarding on No Reply
- Hotline
- Call hold
- DND
- Three-way calling (1/2/4 port support)
- Voice mail
- Direct IP Call

2 Basic Operations

2.1 Methods to Number Dialing

Dial mobile phone or extension number

- ▶ Dial the number directly and wait for 3 seconds (Default “No dial timeout”);
- ▶ Dial the number directly and press #.

2.2 Direct IP Calls

The DAG1000-8S gateway allows users to directly call through IP address. Under this circumstance, the user only needs an analog phone which is connected to a FXS port of the gateway, and calls can be established without registering.

Calls can be established through IP address as long as one of the following conditions is met.

- ▶ Both the DAG1000-8S and other VoIP device have public IP addresses;
- ▶ The DAG1000-8S and other VoIP device use private IP addresses of a same LAN;
- ▶ The DAG1000-8S and other VoIP device can be connected through a router and use public or private IP addresses (with necessary port forwarding or DMZ).

Operation Process:

Step1: Pick up the analog phone and then dial “*47”;

Step2: Enter the target IP address.

【Note】 : No dial tone will be played between step 1 and step 2

Example:

Assume that the target IP address is 192.168.0.160, user need to dial *47 and then 192*168*0*160. After that, press the “#” key or wait 3 seconds. Then signaling interaction is completed and ringing tone can be heard.

【Note】 : You cannot make direct IP calls between FXS0 to FXS1 of a same DAG1000-8S since they are using same IP addresses. Call through IP address is only routed to the default destination port 5060.

2.3 Call Holding

Place a call on hold by pressing the “flash” button on the analog phone (if the phone has the button). Press the “flash” button again to release the previously held caller and resume conversation. If no “flash” button is available, use “hook flash” instead.

2.4 Call Waiting

If a calling party places a call to a called party which is otherwise engaged, and the called party has the call waiting feature enabled, the calling party will hear a IVR voice ‘Please hold on, the subscriber you dialed is busy’ and the called party will hear three beeps.

By pressing the flash button or the flash hook, the called party is able to switch between the new incoming call and the current call.

2.5 Call Transfer

2.5.1 Blind Transfer

Blind transfer is used to transfer call to a third party without informing the caller. Assume that A and B are in a conversation. A wants to blind Transfer B to C:

- ▶ A presses **FLASH** on the analog phone to hear the dial tone;
- ▶ Then A dials *87 and C’s number and # (or wait for 4 seconds);
- ▶ A will hear the confirm tone. Then, A hangs up, and B and C enter into a conversation.

Note:

“*Call features enable*” must be set to “Yes” on WEB configuration page. Caller A can place a call on hold and wait for one of the three situations:

- ▶ A quick confirmation tone (similar to call waiting tone) which follows the dial tone. This indicates the transfer is successful. At this point, Caller A can either hand up or make another call.
- ▶ A quick busy tone which follows a restored call (on supported platforms only). This means the transferee has received a 4xx response for the INVITE and we will try to recover the call. The busy tone indicates the transfer has failed.
- ▶ Continuous busy tone. This means the call has timed out.

2.5.2 Attended Transfer

Attended transfer allows the transferring party either connects the call to a ringing phone (ring back heard) or speaks with the third party before transferring the call to the third party.

Assume that A and B are in conversation. Caller A wants to *attended transfer* B to C:

- ▶ A presses **FLASH** on the analog phone and wait for dial tone;
- ▶ Then dial C's number followed by # (or wait for 3 seconds);
- ▶ If C answers the call, A and C are in conversation. Then A can hang up to complete the transfer;
- ▶ If C does not answer the call, A can press "flash" to resume call with B.

2.6 Three-way Calling

Three-way calling:

- ▶ A calls B, B picks up the phone, then A and B enters into conversation;
- ▶ A presses the hook flash, and the call between A and B is placed on hold. Then C calls A and A answers the call.
- ▶ A presses hook flash again, then the calls between A and B and between A and C are placed on hold.

At this time, if A presses 1, conversation between A and B is resumed; if A presses 2, conversation between A and C is resumed; if A presses 3, A, B and C enter into conversation.

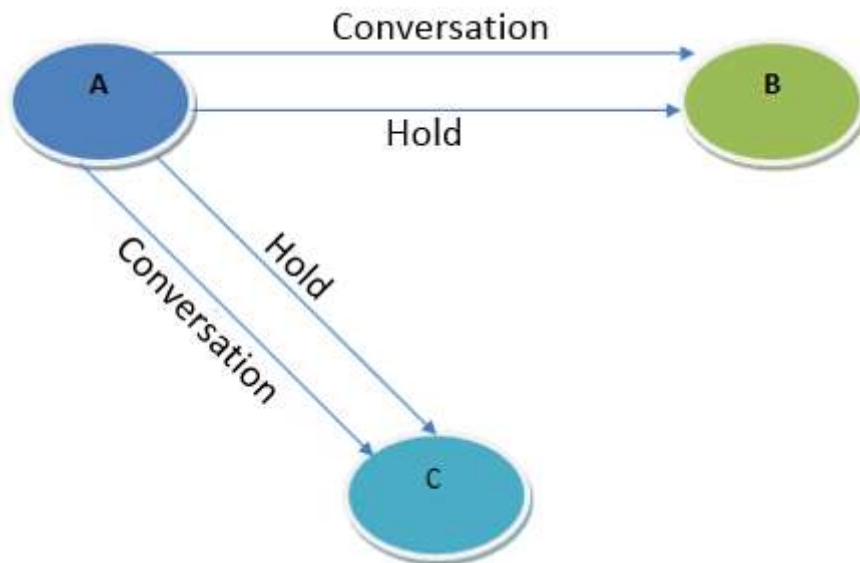

2.7 Description of Feature Codes

The DAG1000-8S gateway supports all traditional and senior phone functions. It provides feature codes for easy maintenance and easy entry to phone functions.

| Feature Codes | Corresponding Function |
|---------------|--|
| *158# | Dial *158# to inquiry the IP address of LAN port |
| *159# | Dial *159# to inquiry the IP address of WAN port |

| | |
|---------------------|---|
| *114# | Dial *114# to inquire port account |
| *150* | Dial *150* to set the way of obtaining IP address |
| *157* | Dial *157*0 to set route mode; dial *157*1 to set bride mode |
| *152* | Dial *152* to set IPv4 address |
| *153* | Dial *153* to set subnet mask |
| *156* | Dial *156* to set default gateway's IP address |
| *193# | Dial *193# to renew the IP address |
| *160*1# | Dial *160*1# to open WAN port to visit web |
| *166*000000# | Dial *166*000000# to reset to factory defaults |
| *111# | Dial *111# to restart the gateway |
| *# | Dial *# to place a call on hold |
| *47* | Dial *47* to establish a call through IP address |
| *51# | Dial *51# to enable 'call waiting' feature |
| *50# | Dial *50# to disable 'call waiting' feature |
| *87* | Dial *87* to blind transfer a call |
| *72* | Dial *72* to enable 'unconditional call forwarding' feature |
| *73# | Dial *73# to disable 'unconditional call forward' feature |
| *90* | Dial *90* to enable 'busy call forwarding' feature |
| *91# | Dial *91# to disable 'busy call forwarding' feature |
| *92* | Dial *92* to enable 'no answer call forwarding' feature |
| *93# | Dial *93# to disable 'no answer call forwarding' feature |
| *78# | Dial *78# to enable DND |
| *79# | Dial *79# to disable DND |
| *200# | Dial *200# to access voice mail |
| Flash/Hook | Used to switch between incoming calls. If the phone is not in session, flash/hook will switch a new channel for a new call. |

2.8 Sending and Receiving Fax

The DAG1000-8S gateway supports four fax modes:

- ▶ T.38 (FoIP)
- ▶ Pass-Through
- ▶ Modem
- ▶ Adaptive

2.8.1 T. 38 and Pass-Through

T.38 is the preferred fax mode because it is more reliable and works well in most network conditions. If the service provider supports T.38, please use this method by selecting T.38 as fax mode (default). If the service provider does not support T.38, pass-through mode may be used. If you have problems with sending or receiving Fax, toggle the Fax Tone Detection Mode setting.

2.9 Local IVR Operation

2.9.1 Inquire IP address

Connect analog phone to FXS ports of the DAG1000-8S gateway, then pick up the phone. After dialing tone, dial *158# to inquire the IP address of LAN port and dial *159# to inquire the IP address of WAN port.

2.9.2 Factory Reset

Pick up the phone, and then dial *166*000000#. After hearing a voice prompt of 'setting successfully', hang up the phone and the gateway is reset to factory defaults.

2.9.3 Configure LAN Port's IP Address

Before configuration, please ensure:

- ▶ The gateway is power on;
- ▶ Device has been connected to network;
- ▶ Telephone is connected to FXS port of the DAG1000-8S gateway.

Configure dynamic IP address by DHCP:

Pick up the phone, dial *150*2# and then hang up the phone.

If the voice prompt indicates 'setting successfully', please restart the gateway after 10 seconds.

Configure Static IP address:

Take the configuration of IP address '172.16.0.100' as example.

Pick up the phone, dial *150*1# and then hang up the phone.

Then configure IP address and mask as follow:

- Configure IP address

Pick up the phone, dial *152*172*16*0*100# and then hang up the phone.

- Configure subnet mask

Pick up the phone, dial *153*255*255*0*0# and then hang up the phone.

- Configure gateway IP address

Pick up the phone, dial *156*172*16*0*1# and then hang up the phone.

- Query the IP address of the DAG1000-8S gateway:

Pick up the phone, dial *158#.

If the gateway uses PPPoE method to get IP address, the IP address needs to be configured through web browser.

【Note】 : The telephone will play voice prompt "setting successfully" if the step is correct.

3 Configurations on Web Interface

3.1 Network Connection

DAG1000-8S works in two modes: route mode and bridge mode. When it is under the route mode, the IP of WAN port must be different from the IP of LAN port. But when it is under the bridge mode, the IP of WAN and the IP of LAN are the same.

Under the route mode, the default IP address of WAN port is a DHCP IP address, while the default IP address of the LAN port is 192.168.11.1.

Under the bridge mode, both the default IP addresses of the WAN port and the LAN port are 192.168.11.1.

Connect the DAG1000-8S gateway to the network according to the following network topology, and dial *158 to query the IP address of the gateway.

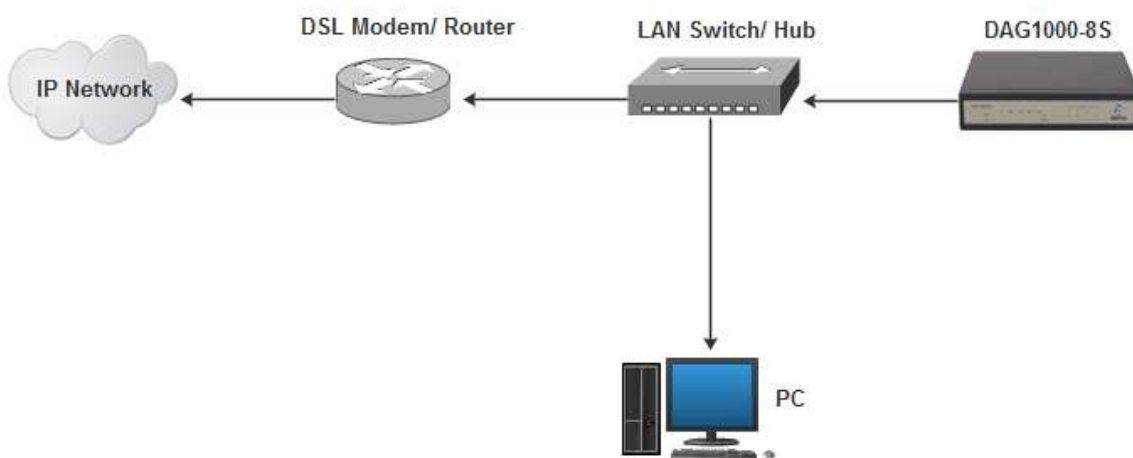

3.2 Preparations for Login

Modify the IP address of the PC to make it at the same network segment with the DAG1000-8S device, since the default IP address of the gateway is 192.168.11.1.

Take Windows 7 as an example, the IP address of PC is changed into 192.168.11.10:

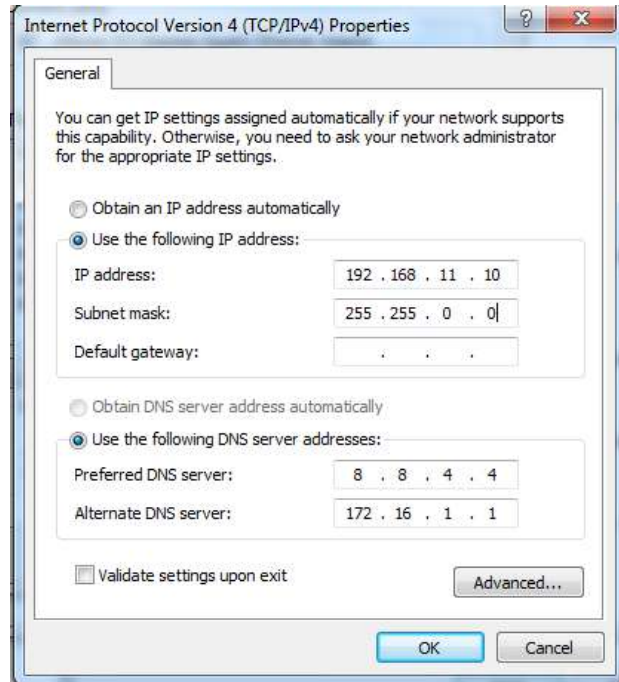

Check the connectivity between the PC and the gateway. Click **Start** → **Run** of PC and enter cmd to execute 'ping 192.168.11.1' to check whether the IP address of the DAG1000-8S gateway runs normally.

3.3 Log in Web Interface

Open a web browser and enter the IP address of the LAN port of the DAG1000-8S (the default IP of LAN port is 192.168.11.1, while that of WAN port is obtained via DHCP by default). Then the login GUI will be displayed. Both the default username and password are admin.

It is advised to modify the username and password for security consideration.

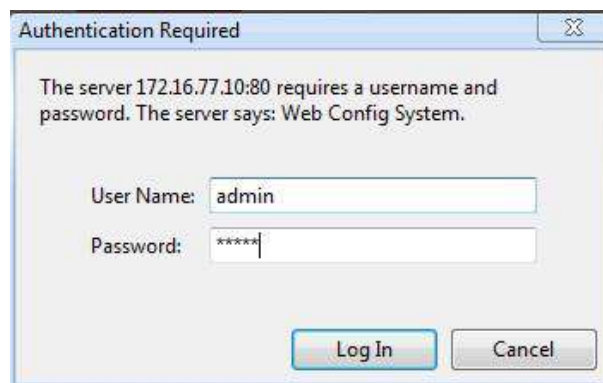

Enter default username and password: admin/admin, then click "Log in" to enter into the Web interface. And then you can see the following web interface.

The screenshot displays the 'Web Management System' interface for a Dinstar device. On the left is a navigation tree with categories like Status & Statistics, Network, SIP Server, Port, Advanced, Call & Routing, Manipulation, Management, Security, and Tools. The main content area shows 'System Information' with the following details:

| | | | |
|--------------------------|---|--------------------|--------|
| Device ID | da00-0040-9700-0571 | | |
| MAC Address | F3-A0-3D-20-3E-94 | | |
| Network Mode | Router | | |
| WAN IP Address | 172.10.222.111 | 200.205.0.0 | Static |
| | 172.16.1.1 | | |
| LAN Port | 182.108.11.1 | 200.205.205.0 | |
| DNS Server | 114.114.114.114 | 4.4.4.4 | |
| Cloud Register Status | Registered | | |
| DBORegStatus | Not Registered | | |
| System Uptime | 0h: 00m: 30s | | |
| NTP Status | Succeed | | |
| NTP Time | 2015-4-19 03:42:48 | | |
| WAN Traffic Stat. | Received: 2029855 bytes | Sent: 198773 bytes | |
| Usage of Flash | 09.1%(10789004 / 23311052) bytes | | |
| Usage of RAM in Linux | 32.1%(38785898 / 112092484) bytes | | |
| Usage of RAM in AOS | 21.1%(7200304 / 33640240) bytes | | |
| Current Software Version | DAG1000-8S 2.18.02.21 PCB 0 LOGIC 0 BIOS 1, 2015-04-15 22:05:06 | | |
| Backup Software Version | DAG1000-96 2.18.02.18 PCB 0 LOGIC 0 BIOS 1, 2015-06-08 15:49:14 | | |
| DSP Version | CS4V_7_B_3 | | |
| U-BOOT Version | 8 | | |
| Kernal Version | 11 | | |
| FS Version | 1.0.13 | | |
| Hint Language | English | | |

A 'Refresh' button is located at the bottom right of the system information panel.

3.4 Navigation Tree

The web management system of the DAG1000-8S VoIP gateway consists of the navigation tree and detailed configuration interfaces.

Choose a node of the navigation tree to enter into a detailed configuration interface.

- **Status & Statistics**
 - System Information
 - Registration
 - TCP/UDP Traffic
 - RTP Session
 - CDR
 - Record Statistics
- + **Quick Setup Wizard**
- + **Network**
- SIP Server
- Port
- + **Advanced**
- + **Call & Routing**
- + **Manipulation**
- + **Management**
- + **Security**
- + **Tools**

Note: When the gateway works under the bridge mode, configuration items including "Routing Configuration", "DHCP Service", "DMZ Host", "Forward Rules" and "Static Routing" and "ARP" will not be displayed.

3.5 State and Statistics

3.5.1 System Information

On the System Information interface, you can view the information of device ID, MAC address, network mode, IP addresses, version information, sever register status and so on.

| System Information | | | |
|--------------------------|---|-------------------|--------|
| Device ID | da00-0040-9700-0571 | | |
| MAC Address | F8-A0-3D-20-3B-84 | | |
| Network Mode | Router | | |
| WAN IP Address | 172.16.222.111 | 255.255.0.0 | Static |
| | 172.16.1.1 | | |
| LAN Port | 192.168.11.1 | 255.255.255.0 | |
| DNS Server | 114.114.114.114 | 4.4.4.4 | |
| Cloud Register Status | Registered | | |
| DBORegStatus | Not Registered | | |
| System Uptime | 0h: 06m: 30s | | |
| NTP Status | Succeed | | |
| NTP Time | 2016-4-19 03:43:45 | | |
| WAN Traffic Stat. | Received 2829655 bytes | Sent 166778 bytes | |
| Usage of Flash | 59 %(16789504 / 28311552) bytes | | |
| Usage of RAM in Linux | 32 %(36765696 / 112062464) bytes | | |
| Usage of RAM in AOS | 21 %(7266304 / 33546240) bytes | | |
| Current Software Version | DAG1000-8S 2.18.02.21 PCB 0 LOGIC 0 BIOS 1, 2016-04-15 22:05:06 | | |
| Backup Software Version | DAG1000-8S 2.18.02.18 PCB 0 LOGIC 0 BIOS 1, 2015-09-08 15:49:14 | | |
| DSP Version | C64V_7_8_3 | | |
| U-BOOT Version | 8 | | |
| Kernel Version | 11 | | |
| FS Version | 1.0.13 | | |
| Hint Language | English | | |

Figure 3.5-1 System Information

Explanation of items on System Information interface

| | |
|------------------------------|---|
| Device ID | A unique ID of each device. This ID is used for warranty and cloud server authentication. |
| MAC address | Hardware address of the WAN port |
| Network Mode | Network modes include bridge and router. Under the Bridge mode , the network port will work as a small LAN switch. Under the Router Mode , NAT feature will be enabled under this mode. |
| IP Address | <p>The IP address of the WAN port of the gateway is shown.</p> <p>DHCP: Obtain IP address automatically. DAG1000-8S is regarded as a DHCP client, which sends a broadcast request and looks for a DHCP server from the LAN to answer. Then the first discovered DHCP server automatically assigns an IP address to the DAG1000-8S from a defined range of numbers.</p> <p>Static IP Address: Static IP address is a semi-permanent IP address and remains associated with a single computer over an extended period of time. This differs from a dynamic IP address, which is assigned <i>ad hoc</i> at the start of each session, normally changing from one session to the next.</p> <p>If you choose static IP address, you need to fill in the following information:</p> <ul style="list-style-type: none"> ● IP Address: the IP address of the WAN port of the DAG1000-8S; ● Subnet Mask: the netmask of the router connected the DAG1000-8S; ● Default Gateway: the IP address of the router connected the DAG1000-8S; <p>PPPoE: PPPoE is an acronym for point-to-point protocol over Ethernet, which relies on two widely accepted standards: PPP and Ethernet. PPPoE is a specification for connecting the users on an Ethernet to the Internet through a common broadband medium, such as a single DSL line, wireless device or cable modem. PPPOE IP address refers to IP address assigned through the PPPoE mode.</p> <p>If you choose PPPoE, you need to fill in to fill in the following information:</p> <ul style="list-style-type: none"> ● Username: the account name of PPPoE ● Password: the password of PPPoE ● Server Name: the name of the server where PPPoE is placed |
| DNS Server | IP address of DNS server and default gateway information is displayed. |
| Cloud Register Status | Whether the DAG1000-8S gateway is registered to cloud or not. |
| System Uptime | The running time of the DAG1000-8S since it is powered on. |

| | |
|---------------------------------|--|
| NTP Status | Succeed: the DAG1000-8S gateway is sync to NTP server successfully; Failed: the DAG1000-8S gateway fails to be sync to NTP server. Then you should check network connection and the NTP server. |
| Network Traffic Statics | Total bytes of message received and sent by network port. |
| Usage of Flash | Detailed usage of Flash memory |
| Usage of RAM in Linux | Detailed RAM usage of Linux core |
| Usage of RAM in AOS | Detailed RAM usage of AOS |
| Current Software Version | The software version that runs on the gateway. Model name, version number and the software development date are displayed. |
| Backup Software Version | Backup software is for the purpose of backup. When the current software fails, the backup software version will work. |
| U-boot | U-boot version |
| Kennel version | Linux Kennel version |
| FS Version | File system version |
| Hint Language | The current language of the DAG1000-8S gateway |

3.5.2 Registration Information

| Port Registration Information | | | | | |
|-------------------------------|------|-----------------|---------------------|-------------------|-----------------------|
| Port No. | Type | Primary User ID | Primary User Status | Secondary User ID | Secondary User Status |
| 0 | FXS | 5600 | Registered | --- | --- |
| 2 | FXS | 4000 | Registered | --- | --- |

| Port Group Registration Information | | | | | |
|-------------------------------------|------|-----------------|---------------------|-------------------|-----------------------|
| Port Group | Port | Primary User ID | Primary User Status | Secondary User ID | Secondary User Status |
| --- | --- | --- | --- | --- | --- |

Figure 3.5-2 Port and Port Group Registration Information

Primary/Secondary User status:

- ▶ Registered: the port is registered to SIP server successfully;

- ▶ Unregistered: the port fails to be registered to SIP server.

3.5.3 TCP/UDP Statistics

| TCP/UDP Traffic | | | |
|------------------|------------------|------------------|------------------|
| TCP Sent Packets | TCP Recv Packets | UDP Sent Packets | UDP Recv Packets |
| 1092 | 820 | 567 | 311 |

Figure 3.5-3 TCP/UDP Statistics Information

The above interface shows the statistical number of sending or receiving packets over TCP, and the number of sending or receiving packets over UDP since the DAG1000-8S is booted up.

3.5.4 RTP Session Statistics

| RTP Session | | | | | | | | | | |
|-------------|--------------|---------------|------------|--------------|-----------|--------------|--------------|--------------|--------|-------------|
| Port | Payload Type | Packet Period | Local Port | Peer IP | Peer Port | Sent Packets | Recv Packets | Lost Packets | Jitter | Duration(s) |
| 2 | T.38 | 20 | 8008 | 172.16.95.50 | 8000 | 487 | 273 | 0 | 0 | 27 |

Figure 3.5-4 RTP Session Statistics

The above interface shows real-time RTP session information, including: port, payload type, packet period, local port, peer IP, peer port, sent packets, receive packets, lost packets, jitter and duration.

3.5.5 CDR Statistics

CDR (Call Detail Record): is a data record produced by a telephone exchange or a telecommunication device, which contains the details of a telephone call that passes through the device.

| CDR Report | | | | | | | | | | | | | |
|---|---|---------------------------------------|-------------------------------------|--------------------------------------|-------------|--------|-------|--------|-------------|---------|---------|---------|-----------|
| Enable CDR | <input checked="" type="radio"/> No <input type="radio"/> Yes | | <input type="button" value="save"/> | | | | | | | | | | |
| Port | <input type="text" value="All"/> | Source <input type="text"/> | | Destination <input type="text"/> | | | | | | | | | |
| CDR Oper | <input type="button" value="Export"/> | <input type="button" value="Filter"/> | | <input type="button" value="Clear"/> | | | | | | | | | |
| Total: 0Item 50Item/Page 1/1Page <input type="text" value="Page1"/> | | | | | | | | | | | | | |
| Port | Start Date | Answer Date | Direction | Source | Destination | PeerIP | Codec | Reason | Duration(s) | RTPSend | RTPRecv | RTPLoss | Jitter(s) |

On the **Status & Statistic** → **CDR** interface, details of all calls through the ports of the DAG1000-8S are displayed. The CDR function can be enabled on this interface.

3.6 Quick Setup Wizard

Quick setup wizard guides user to configure the device step by step. User only needs to configure network, SIP server and SIP port in the Quick Setup Wizard interface. Basically, after these three steps, user is able to make voice call via the DAG1000-8S device.

3.7 Network Configuration

3.7.1 Local Network

The DAG1000-8S gateway has two kinds of network mode: route and bridge. When the gateway works under the route mode, it will work as a small router and NAT function is enabled. Under this situation, WAN port is normally connected to router/switch or ADSL MODEM, while LAN port is connected local computer or other network device (such as Ethernet switches, Hubs etc.).

When the gateway works under the bridge mode, WAN port and LAN port are the same. The gateway serves as a four-port Ethernet switch. Under this network mode, user only needs to configure the IP address of WAN port and DNS.

Under the route mode, the default IP address of LAN port is displayed and it can be changed by user.

Local Network

IP Protocol IPv4

Network Mode Route Bridge

WAN Port

Obtain an IP address automatically

Use the following IP address

IP Address

Subnet Mask

Default Gateway

PPPoE

Account

Password

Service Name

WAN MTU

LAN Port

IP Address

Subnet Mask

LAN MTU

DNS Server

Obtain DNS server address automatically
 Use the following DNS server address

Primary DNS Server
 Secondary DNS Server

Figure 3.7-1 Route Mode

Local Network

IP Protocol

Network Mode Route Bridge

Network Configuration

Obtain an IP address automatically
 Use the following IP address

IP Address
 Subnet Mask
 Default Gateway

PPPoE
 Account
 Password
 Service Name

WAN MTU

DNS Server

Obtain DNS server address automatically
 Use the following DNS server address

Primary DNS Server
 Secondary DNS Server

Figure 3.7-2 Bridge Mode

- ▶ When “Obtain IP address automatically” is selected, the gateway will obtain IP address by DHCP.
- ▶ When “Use the following IP address” is selected, user needs to configure a static IP address.
- ▶ When “PPPoE” is selected, user needs to fill in the account and password offered by ISP.

【Notes】 :

- If DHCP is selected to obtain IP address, please ensure DHCP server in the network works normally.

- When the gateway works under the route mode, the IP address of LAN port and that of WAN port cannot be at the same network segment, otherwise the gateway can't work normally.
- When the gateway works under the route mode, log in the gateway's web configuration interface via the LAN port.
- After the configurations are finished, please restart the gateway for the configurations to take effect.

3.7.2 VLAN (Virtual Local Area Network)

In order to control the impacts brought by broadcast storms, user can divide VLANs into three groups, namely VLAN1, VLAN2 and VLAN3. There are kinds of VLAN, including data VLAN, voice VLAN and management VLAN. Different kind of VLAN has different messages.

▶ 802.1Q

The IEEE 802.1Q standard defines the architecture for Virtual Bridged LANs, the services provided in Virtual Bridged LANs and the protocols and algorithms involved in the provision of those services.

No Quality of Service mechanisms are defined in this standard, but an important requirement for providing QoS is included in this standard, e.g. the ability to regenerate user priority of received frames using priority information contained in the frame and the User Priority Regeneration Table for the reception Port.

▶ 802.1P

IEEE 802.1P standard, describes important methods for providing QoS at MAC level. IEEE 802.1p is in fact quite good. Lower priority level packets are not sent, if there are packets in queued in higher level queues. IEEE 802.1p describes no admission control protocols. It would be possible to give Network Control priority to all packets and the network would be easily congested.

- ▶ “IP Expire Time” means the service time of an assigned IP address. When the service time expires, the IP address will no longer be by the network equipment.
- ▶ The subnet mask, gateway, DNS and other information will be transferred to the network equipment through the DHCP protocol.

| DHCP Server Config | |
|---------------------------------|--|
| DHCP Server | <input checked="" type="checkbox"/> Enable |
| IP Pool Starting Address | 192.168.11.100 |
| IP Pool Ending Address | 192.168.11.199 |
| IP Expire Time | 72 h |
| Subnet Mask (Optional) | 255.255.255.0 |
| Default Gateway (Optional) | 192.168.11.1 |
| Primary DNS Server (Optional) | 192.168.11.1 |
| Secondary DNS Server (Optional) | |

Figure 3.7-4 DHCP Server Configuration Interface

【Note】 : When configuring the start IP address, end IP address, subnet mask and gateway IP address, please set them at the same network segment with the IP address of LAN port. Otherwise, other devices under the network will not work normally after they get the IP address assigned by the DHCP server. After the configurations are finished, please restart the DAG1000-8S for the configurations to take effect.

3.7.4 DMZ Host (Route Mode)

If the DMZ service is enabled, the devices in the wide-area network are allowed to have direct access to the devices in the DMZ (demilitarized zone). In this way, devices in the wide-area network can visit the devices which are in the local area network and meanwhile the devices in the local area network are protected.

| DMZ Host | |
|-------------------------------------|--|
| DMZ Host IP Address | <input type="text"/> <input type="checkbox"/> Enable |
| <input type="button" value="Save"/> | |

Figure 3.7-5 DMZ Configuration Interface

【Note】 After the configurations are finished, please restart the DAG1000-8S for the configurations to take effect.

3.7.5 Forward Rule (Route Mode)

Sometimes, a device under the LAN network needs to provide a port for communication with the WAN network (such as providing the port 21 for FTP service). In those cases, user can configure forwarding rules for that network device.

| Forward Rule Table | | | | |
|--------------------|----------------------|----------------------|--------------------------------------|--------------------------|
| ID | Server Port | IP Address | Protocol | Enable |
| 1 | <input type="text"/> | <input type="text"/> | TCP <input type="button" value="v"/> | <input type="checkbox"/> |
| 2 | <input type="text"/> | <input type="text"/> | TCP <input type="button" value="v"/> | <input type="checkbox"/> |
| 3 | <input type="text"/> | <input type="text"/> | TCP <input type="button" value="v"/> | <input type="checkbox"/> |
| 4 | <input type="text"/> | <input type="text"/> | TCP <input type="button" value="v"/> | <input type="checkbox"/> |
| 5 | <input type="text"/> | <input type="text"/> | TCP <input type="button" value="v"/> | <input type="checkbox"/> |
| 6 | <input type="text"/> | <input type="text"/> | TCP <input type="button" value="v"/> | <input type="checkbox"/> |
| 7 | <input type="text"/> | <input type="text"/> | TCP <input type="button" value="v"/> | <input type="checkbox"/> |
| 8 | <input type="text"/> | <input type="text"/> | TCP <input type="button" value="v"/> | <input type="checkbox"/> |

Figure 3.7-6 Configuration Interface for Forwarding Rules

Service port is the port that provides service for the WAN network, while IP address is the IP address of the network device under the LAN network. The protocol is TCP or UDP.

The different between forwarding rule and DMZ host is that DMZ Host offers all ports (0-1024) and protocols for outside telecommunication while forwarding rule only offers a single or several ports and protocols of TCP or UDP.

When both DMZ Host and forwarding rule are configured, the configuration of forwarding rule is prior to that of DMZ Host.

3.7.6 Static Route (Route Mode)

Static route determines the routing rule during the handling of messages by the gateway. Most of time, user does not need to configure static route. Only when there are multiple network segments in the LAN network and these segments need to complete some specific applications, static route needs to be configured.

| Static Route Table | | | | |
|--------------------|----------------------|----------------------|----------------------|--------------------------|
| ID | Dest. IP Address | Subnet Mask | Nexthop | Enable |
| 1 | <input type="text"/> | <input type="text"/> | <input type="text"/> | <input type="checkbox"/> |
| 2 | <input type="text"/> | <input type="text"/> | <input type="text"/> | <input type="checkbox"/> |
| 3 | <input type="text"/> | <input type="text"/> | <input type="text"/> | <input type="checkbox"/> |
| 4 | <input type="text"/> | <input type="text"/> | <input type="text"/> | <input type="checkbox"/> |
| 5 | <input type="text"/> | <input type="text"/> | <input type="text"/> | <input type="checkbox"/> |
| 6 | <input type="text"/> | <input type="text"/> | <input type="text"/> | <input type="checkbox"/> |
| 7 | <input type="text"/> | <input type="text"/> | <input type="text"/> | <input type="checkbox"/> |
| 8 | <input type="text"/> | <input type="text"/> | <input type="text"/> | <input type="checkbox"/> |

Figure 3.7-7 Configuration interface for Static Route

3.7.7 ARP

ARP is address resolution protocol. ARP helps user get the MAC address of a device through its IP address. Under TCP/IP network environment, each host is assigned with a 32-bit IP address, but MAC address needs to be known for message transmission in the physical network. ARP is a tool that converts IP address into MAC address.

| ARP | |
|-------------------------------------|---|
| Type | <input checked="" type="radio"/> Static <input type="radio"/> Dynamic |
| IP Address | MAC Address |
| --- | --- |
| Total: 0 entry <input type="text"/> | |

Figure 3.7-9 ARP Parameters

3.8 SIP Server

Introduction of SIP Server:

- 1) SIP server is the main component of VoIP network and is responsible for establishing all the SIP calls. SIP server is also called SIP proxy server or register server. Both IPPBX and softswitch can act as the role of SIP server.
- 2) Usually, SIP server does not participate in media processing. Under SIP network, media always use end-to-end negotiating. Simple SIP server is only responsible for the establishment, maintenance and cleaning of sessions, while relatively-complex SIP server (SIP PBX) not only

provides basic calling and conversational support, but also offers rich services such as Presence, Find-me and Music On Hold.

- 3) SIP server based on Linux platform, such as: OpenSER, sipXecx, VoS, Mera etc.
- 4) SIP server based on windows platform, such as :mini SipServer, Brekeke, VoIPswitch etc.
- 5) Carrier-grade soft switch platform, such as Cisco, Huawei, ZTE etc.

SIP Server

Primary SIP Server

Primary SIP Server Address

Primary SIP Server Port (Default: 5060)

Registration Expires (Default: 1800) s

Heartbeat Enable

Secondary SIP Server

Secondary SIP Server Address

Secondary SIP Server Port (Default: 5060)

Registration Expires (Default: 1800) s

Heartbeat Enable

Primary Outbound Proxy

Primary Outbound Proxy Address

Primary Outbound Proxy Port

Secondary Outbound Proxy

Secondary Outbound Proxy Address

Secondary Outbound Proxy Port

Registration

Retry Interval when Registration failed s

Registration times per second (0 means unlimited)

SIP Transport Type

Local SIP Port

Use Random Port Enable

SIP UDP/TCP Local Port

SIP TLS Local Port

Figure 3.8-1 Configuration Interface for SIP Server

Explanation for SIP parameters:

| | |
|--|---|
| Primary SIP Server Address | The IP address or domain name of the primary SIP server. They are provided by VoIP service provider. |
| Primary SIP Server port | The Service port of the primary SIP server. It is 5060 by default. |
| Registration Expires | It is used to avoid excessively frequent registrations. When the time that is set expires, terminals will send register request to the primary SIP server. The time is 1800s by default. |
| Heartbeat | Heartbeat is used to check the connection between terminal and SIP server. |
| Secondary SIP Server address | The IP address or domain name of the backup SIP server. They are provided by VoIP service provider. |
| Secondary SIP Server port | Service port of the backup SIP server. It is 5060 by default. |
| Registration Expires | It is used to avoid excessively frequent registrations. When the time that is set expires, terminals will send register request to the backup SIP server. The time is 1800s by default. |
| Secondary SIP heartbeat | Heartbeat is used to check the connection between terminal and SIP server. |
| Outbound Proxy Address | Outbound proxy IP address or domain name provided by VoIP service provider. |
| Outbound Proxy Port | Default outbound proxy port is 5060. |
| Retry Interval when Registration failed | The retry interval time after a registration fails. Default: 30s |
| Registration times per second | The maximum number of registrations in a second. 0 means no limitation for registrations. |
| SIP Transport Type | The way of SIP-based transmission. It can be UDP, TCP and Auto. Default: UDP. |
| Use Random Port | The SIP port for providing services for terminal is chosen by random. |

| | |
|-----------------------|---|
| SIP Local Port | Default SIP local service port is 5060. |
|-----------------------|---|

3.9 Port

Port Modify

| | |
|---|--|
| Port | <input type="text" value="0"/> |
| Disable Port | <input type="checkbox"/> |
| Registration | <input checked="" type="checkbox"/> Enable |
| Primary Display Name | <input type="text"/> |
| Primary SIP User ID | <input type="text" value="8001"/> |
| Primary Authenticate ID | <input type="text" value="8001"/> |
| Primary Authenticate Password | <input type="password" value="....."/> |
| Secondary Display Name | <input type="text"/> |
| Secondary SIP User ID | <input type="text"/> |
| Secondary Authenticate ID | <input type="text"/> |
| Secondary Authenticate Password | <input type="password"/> |
| Offhook Auto-Dial | <input type="text"/> |
| Auto-Dial Delay Time | <input type="text" value="0"/> s |
| DND(Do Not Disturb) | <input type="checkbox"/> Enable |
| Caller-ID | <input checked="" type="checkbox"/> Enable |
| Number for CFU(Call Forwarding Unconditional) | <input type="text"/> |
| Number for CFB(Call Forwarding Busy) | <input type="text"/> |
| Number for CFNRy(Call Forwarding No Reply) | <input type="text"/> |
| Call Waiting | <input type="checkbox"/> Enable |
| Play Call Waiting Tone | <input type="checkbox"/> Enable |

Figure 3.9-1 Port Configuration Interface

Explanations for port parameters:

| | |
|-------------|-------------|
| Port | Port number |
|-------------|-------------|

| | |
|--|---|
| Disable port | Whether to disable port temporarily |
| Registration | Whether to enable registration for the port |
| Primary /Secondary SIP Display Name | Primary /Secondary SIP account description. It is used to identify the SIP account |
| Primary /Secondary SIP User ID | User account information provided by VoIP service provider (ITSP). Usually in the form of digit similar to phone number or actually a phone number. |
| Primary/Secondary SIP Authenticate ID | SIP service subscriber's authenticate ID used for authentication. It can be identical to or different from SIP User ID. |
| Primary/Secondary Authenticate password | SIP password which registers to soft switch/SIP server |
| Offhook Auto-dial | An extension or phone number is pre-assigned here so that the number is automatically dialed as soon as user picks up the phone |
| Auto-dial Delay Time | How long the auto-dial number is prolonged. If it is set as 3s, the auto-dial number is dialed after 3 seconds passed. |
| DND | Do not disturb, the phone won't receive any calls in case it enabled |
| Caller ID | Enable or disable caller ID for corresponding port. If it is disabled, the caller ID for the calls through the port won't be displayed. |
| Number for CFU | Call forward unconditional. All incoming calls will be forwarded to pre-assigned number automatically |
| Number for CFB | Call forward on busy. If the line is busy, the call will be forwarded to pre-assigned number automatically |
| Number for CFNRy | Call forward no reply. If the call is not answered, the call will be forwarded to pre-assigned number automatically |
| Call Waiting | If call waiting is enabled, a special tone is sent if another caller tries to reach you |
| Play Call Waiting Tone | If call waiting tone is enabled, caller will hear special tone. |

3.10 Advanced

3.10.1 FXS/FXO Parameters

FXS parameters include: timeout Call Progress Tone, Timeout for Dialing, Send Polarity Reversal etc.

| FXS / FXO | |
|------------------------------------|--|
| Timeout for Dialing | <input type="text" value="5"/> s |
| Timeout for Answer(Outgoing Call) | <input type="text" value="55"/> s |
| Timeout for Answer(Incoming Call) | <input type="text" value="55"/> s |
| No RTP Detected | <input type="checkbox"/> Enable |
| Period without RTP Packet | <input type="text" value="60"/> s |
| Call Progress Tone | <input type="text" value="User Define"/> ▼ |
| Ring Back Tone | <input type="text" value="425,280,425,630,1500,3500,0,0"/> |
| Busy Tone | <input type="text" value="425,280,425,630,500,500,0,0"/> |
| Dial Tone | <input type="text" value="425,280,425,630,200,300,700,800"/> |
| Auto Gain Control | <input type="checkbox"/> Enable |
| Line Parameter | |
| Port | <input type="text" value="Please Select Port"/> ▼ |
| Work Mode | <input type="text" value=""/> ▼ |
| Voice Output Mode | <input checked="" type="radio"/> Telephone <input type="radio"/> Headset |
| Config Mode(Gain) | <input checked="" type="radio"/> Basic <input type="radio"/> Advanced |
| Tx Gain | <input type="text" value=""/> ▼ |
| Rx Gain | <input type="text" value=""/> ▼ |
| FXS Parameter | |
| Send Polarity Reversal | <input type="checkbox"/> Enable |
| Detect Hook Flash | <input checked="" type="checkbox"/> Enable |
| Min Time | <input type="text" value="60"/> ms |
| Max Time | <input type="text" value="400"/> ms |
| CID Type | <input type="text" value="FSK"/> ▼ |
| Modulation Type | <input type="text" value="BFSK Bel202"/> ▼ |
| Message Type | <input type="text" value="MDMF"/> ▼ |
| Message Format | <input type="text" value="Display Name and CID"/> ▼ |
| Send CID before Ringing | <input type="checkbox"/> Enable |
| Delay of Sending CID after Ringing | <input type="text" value="500"/> ms |
| CFNRy Timeout | <input type="text" value="33"/> s |
| SLIC Setting | <input type="text" value="600 Ohm"/> ▼ |
| REN | <input type="text" value="4"/> |
| Long Line Support | <input type="checkbox"/> Enable |

Figure 3.10-1 Configuration Interface for FXS Parameters

Explanation for FXS parameters:

| | |
|---|---|
| Timeout for dialing | With the help of dialing timeout, you can limit the time between two digits while users are typing the digits of a number through an extension. If the timeout expires, the gateway will consider the dialing has finished and will try to send message to SIP server. Default value is 4 seconds. |
| Timeout for answer (Outgoing call) | This parameter determines how long the caller party will wait for answer when making outgoing calls through a phone. |
| Timeout for answer (Incoming call) | This parameter determines how long the phone rings when there are incoming calls |
| No RTP Detected | If this parameter is enabled, the situation will be detected when there is no RTP packets received during the set time period. |
| Period without RTP Packet | The time period when there is no RTP packets received. |
| Call Process Tone | The signal tone standard after a phone is picked up. Choose national standards from the drop-down box. Default value is the United States. |
| Auto Gain Control | Whether to enable automatic gain control |
| Send Polarity Reversal | If polarity reversal is enabled, call tolls will be calculated based on the changes in voltage. If polarity reverse is disabled, you need to set the time for offhook detection and call tolls will be calculated starting from the set time. |
| Detect Hook flash | If 'Detect Hook Flash' is enabled, you need to set a minimum time and a maximum time. If a phone's hook flash is pressed for a time period greater than the set minimum time but less than the maximum time, the action is considered as a 'hook flash' operation. If a phone's hook flash is pressed for more the set maximum time, the action is considered as 'hang up the phone'. |
| CID Type | There are two CID types, namely DTMF and FSK. |
| Message Type | There are two call display types including SDMF and MDMF |
| Message Format | The call display format in analog phone. It can be "Display Name and CID", "CID only", or "Display Name only"; default value is "Display Name and CID" |

| | |
|---|--|
| Send CID before Ringing | If this parameter is enabled, the gateway send Caller ID to phone before ringing, otherwise the caller ID will be displayed after ringing. |
| Delay of sending CID after Ringing | The time how long the caller ID will be delayed when the caller ID is set to be displayed after ringing. Default value is 500ms. |
| CFNRy Timeout | Timeout for 'call forwarding on no answer' service |
| SLIC Setting | Impedance matched with analog phone. |
| Long Line Support | Whether to enable 'Long Analog Extension Line'. |

3.10.2 Media Parameter

Media parameters mainly include: RTP start port, DTMF parameter, Preferred Vocoder, etc.

Media Parameter

Use Random Port Enable

RTP Start Port

UDP Checksum Validation Enable

DTMF Parameter

DTMF Method

RFC2833 Payload Type Preferred(Incoming Call)

RFC2833 Payload Type

DTMF Gain

DTMF Send Interval ms

Send Flash Event Enable

Send DTMF Tone to Analog When Call in Active Enable

Preferred Vocoder

| | Coder Name | Payload Type | Packetization Time(ms) | Rate(kbps) | Silence Suppression |
|-----|-------------------------------------|---------------------------------|---------------------------------|---------------------------------|-------------------------------------|
| 1st | <input type="text" value="G.711A"/> | <input type="text" value="8"/> | <input type="text" value="20"/> | <input type="text" value="64"/> | <input type="text" value="Enable"/> |
| 2nd | <input type="text" value="G.729"/> | <input type="text" value="18"/> | <input type="text" value="20"/> | <input type="text" value="8"/> | <input type="text" value="Enable"/> |
| 3rd | <input type="text"/> | <input type="text"/> | <input type="text"/> | <input type="text"/> | <input type="text"/> |
| 4th | <input type="text"/> | <input type="text"/> | <input type="text"/> | <input type="text"/> | <input type="text"/> |
| 5th | <input type="text"/> | <input type="text"/> | <input type="text"/> | <input type="text"/> | <input type="text"/> |
| 6th | <input type="text"/> | <input type="text"/> | <input type="text"/> | <input type="text"/> | <input type="text"/> |
| 7th | <input type="text"/> | <input type="text"/> | <input type="text"/> | <input type="text"/> | <input type="text"/> |
| 8th | <input type="text"/> | <input type="text"/> | <input type="text"/> | <input type="text"/> | <input type="text"/> |

Codecs Preferred

Figure 3.10-2 Configuration Interface for Media Parameters

Explanation of media parameters:

| | |
|-----------------------------|---|
| Use Random Port | If this parameter is enabled, the gateway will choose a port by random as the start port for RTP. |
| RTP Start Port | Default RTP start port is 8000 |
| DTMF Method | Include SINGAL, INBAND and RFC2833 |
| RFC2833 Payload Type | Payload value, default value is 101 |
| DTMF Gain | Default value is 0 DB |
| DTMF Send Interval | The interval for sending DTMF signal. The default value is 200ms. |
| Send Flash Event | If this parameter is enabled, the gateway will send flash event to remote terminal, and thus user does need to handle it locally |
| Coder Name | The gateway supports G729, G711U, G711A and G723. When outgoing calls are made, G.729 will be used. |
| Payload Type | Each kind of coding has a unique load value, refer to RFC3551. |
| Packetization Time | The time for voice packaging |
| Rate | Voice data flow rate; It is defaulted by system. |
| Silence Suppression | Default value is 'disabled'. If this parameter is enabled, VoIP transmission bandwidth can be saved, and meanwhile network congestion can be avoided. |

3.10.3 SIP Parameters

| SIP Parameter | |
|---|--|
| SUBSCRIBE for MWI(Message Waiting Indicator) | <input type="checkbox"/> Enable |
| MWI Subscription Expires(Default: 3600) | <input type="text" value="3600"/> s |
| Voicemail User ID | <input type="text"/> |
| Visual MWI Type | <input type="text" value="NEON"/> |
| RFC3407 Support | <input type="checkbox"/> Enable |
| IP-to-IP Call | <input checked="" type="checkbox"/> Enable |
| URI includes "user=phone" | <input type="checkbox"/> Enable |
| INVITE with "P-Preferred-Identity" Header (RFC3325) | <input type="checkbox"/> Enable |
| Only Accept Calls from ACL(SIP Server or IP Trunk) | <input type="checkbox"/> Enable |
| Anonymous Call | <input type="checkbox"/> Enable |
| Reject Anonymous Call | <input type="checkbox"/> Enable |
| # as Ending Dial Key | <input type="checkbox"/> Enable |
| # Escape | <input type="checkbox"/> Enable |
| Send # when First Dial Number is "" | <input checked="" type="checkbox"/> Enable |
| Value of "Refer To" refers to "Contact" | <input type="checkbox"/> Enable |
| Third Party Do Not Send 18x Response | <input type="checkbox"/> Enable |
| REFER Delay | <input type="checkbox"/> Enable |
| Send BYE when Recv REFER Response(Unattended) | <input type="checkbox"/> Enable |
| Send New REGISTER when Recv 423 Response | <input checked="" type="checkbox"/> Enable |
| Cseq Start with 1 | <input type="checkbox"/> Enable |
| Forbid Invalid m=line in reINVITE | <input type="checkbox"/> Enable |
| Call Confirm Tone | <input type="checkbox"/> Enable |
| RTP Mode in SDP when Call Holding | <input type="text" value="sendonly"/> |
| Support Call Waiting of Huawei IPPBX | <input type="checkbox"/> Enable |
| Accept Orphan 200 Ok | <input type="checkbox"/> Enable |
| Called Number Preferred | <input type="text" value="Request-Line"/> |
| Caller-ID Preferred | <input type="text" value="From Header"/> |
| Report SDP Whatever | <input type="checkbox"/> Enable |
| 18x Response Preferred | <input type="text" value="18x Response with SDP"/> |
| FlashHook Operation Mode | <input type="text" value="Mode three"/> |
| Wait Dial Time | <input type="text" value="5"/> s |
| Attended Transfer Trigger | <input type="text" value="Flashhook+4"/> |
| Domain Query Type | <input type="text" value="A Query"/> |
| Domain Re-resolution Interval(0 means disable) | <input type="text" value="0"/> min |
| DNS Cache | <input checked="" type="checkbox"/> Enable |

| | |
|--|---------------------------------|
| Session Timer(RFC4028) | <input type="checkbox"/> Enable |
| Session-Expires | 1800 s |
| Min-SE | 1800 s |
| Session Refresh Method | INVITE |
| T1 | 500 ms |
| T2 | 4000 ms |
| T4 | 5000 ms |
| Max Timeout | 32000 ms |
| Heartbeat Interval(1 - 3600) | 10 s |
| Heartbeat Timeout(4 - 64*T1) | 16 s |
| Username of OPTION(Heartbeat) for 'SIP Server' | heartbeat |
| Username of OPTION(Heartbeat) for 'IP Trunk' | heartbeato |

Figure 3.10-3 SIP Parameter Configuration Interface

Explanation of SIP parameters:

| | |
|--|--|
| SUBSCRIBE for MWI (Message Waiting Indicator) | Whether to enable 'voicemail message waiting indicator'; it is realized in the way of NOTIFY |
| MWI Subscription Expires | MWI subscription expiry time; Default value is 3600s. |
| Voicemail User ID | The user ID for access to voicemail box |
| RFC3407 Support | Whether to enable RFC3407 support. |
| IP-to-IP Call | If this parameter is enabled, user can dial IP address through a phone to call destination gateway. |
| URI Includes user=phone | If this parameter is enabled, 'user=phone' will be contained in URI. When calls are routed to PSTN network, the called number will be got from user name. Default value is 'not enable'. |
| INVITE with "P-Preferred-Identity" Header (RFC3325) | If this parameter is enabled, 'P-Preferred-Identity' Header will be added in INVITE message for anonymous call (Support RFC3325). |
| Only Accept Call from ACL (SIP server or IP Trunk) | If this parameter is enabled, the gateway only accepts incoming call from SIP server only. Default value is 'not enable'. |
| Anonymous Call | If this parameter is enabled, 'anonymous' will be included in SIP message. |

| | |
|---|---|
| Reject Anonymous Call | If this parameter is enabled, all anonymous calls will be rejected. Default value is 'not disable'. |
| # as ending Dial Key | '#' is used as the end mark for dialing. |
| # Escape | If this parameter is enabled, '#' is considered as a digit of the number that is dialed. |
| Value of "Refer To" refers to "Contact" | If this parameter is enabled, 'contract header' needs to be filled in in the 'refer to' field of a SIP message. |
| Third Party Do Not Send 18x Response | If this parameter is enabled, the third party will not send 18x response during a attended transfer. |
| Send BYE when Recv REFER Response (unattended) | If this parameter is enabled, the third party will send BYE to release session after receiving REFER during a blind transfer. |
| Send New REGISTER when Recv 423 Response | If this parameter is enabled, the value of 'expires' header will be automatically updated and REGISTER will be re-sent after receiving of 423 response. |
| Implicit Subscribe | If this parameter is enabled, the gateway will accept implicit subscription. |
| CSeq Start with 1 | If this parameter is enabled, the value of CSeq starts with '1'. |
| Forbid Invalid m=line in reINVITE | If this parameter is enabled, the gateway will prevent 'invalid m=line' from being carried in the SDP of re-INVITE. |
| RTP Mode in SDP when Call Holding | Use 'sendonly' or 'inactive' as RTP mode during call holding. |
| Support Call Waiting of Huawei IPPBX | If this parameter is enabled, the gateway will support call waiting of Huawei IPPBX. |
| Accept Orphan 200 OK | If this parameter is enabled, the gateway will support different 'to-tag 200 OK' in an INVITE session |
| Domain Query Type | There are two modes: A QUERY and SRV QUERY. Default is 'A QUERY'. |
| Domain Re-resolution Interval | Default 0: forbidden |
| DNS cache | If this parameter is enabled, the gateway will cache the DNS query results. |
| Early Media | Support the receiving of Early Media. |

| | |
|---|--|
| PRACK(RFC3262) | Support reliable transmission of provisional response |
| PRACK Only for 18x with SDP | Send PRACK only when there's SDP in 18x response |
| Early Answer | If this parameter is enabled, SDP will be contained in 18x |
| Session Timer (RFC4028) | Whether to enable 'session timer', default value is 'no'. |
| Session-Expires | The Session-Expires header field conveys the session interval for a SIP session. |
| Min-SE | Min-SE header field indicates the minimum value for the session interval. |
| T1 | T1 timer of SIP protocol, default is 500ms |
| T2 | T2 timer of SIP protocol, default is 400ms |
| T4 | T4 timer of SIP protocol, default is 500ms |
| Max Timeout | The max timeout of sending or receiving, default is 32s |
| Heartbeat Interval | Default is 10s. |
| Heartbeat Timeout | Default to 16s |
| Username of OPTION(Heartbeat) for "SIP Server" | The user ID part of OPTION SIP message in the heartbeat request for SIP server |
| Username of OPTION(Heartbeat) for "IP TRUNK" | The user ID part of OPTION SIP message in the heartbeat request for IP trunk |

Voicemail instructions:

Here takes the DAG1000-8S gateway together with Elastix as the example to introduce how voicemail works in the gateway.

1) After the gateway registers to Elastix server, enable the voicemail function in Elastix for the corresponding extension number and then set password. As below:

Voicemail & Directory

Status

Voicemail Password

Email Address

Pager Email Address

Email Attachment yes no

Play CID yes no

Play Envelope yes no

Delete Voicemail yes no

IMAP Username

IMAP Password

VM Options

VM Context

VmX Locator

Elastix Voicemail Configuration Interface

2) Check feature code in Elastix and change it if necessary. Its default feature code setting is as follows:

Voicemail

| | | | |
|----------------|----------------------------------|-------------------------------------|--------------------------------------|
| Dial Voicemail | <input type="text" value="*98"/> | <input checked="" type="checkbox"/> | <input type="text" value="Enabled"/> |
| My Voicemail | <input type="text" value="*97"/> | <input checked="" type="checkbox"/> | <input type="text" value="Enabled"/> |

Elastix Voicemail Setting

On the Web interface of DAG1000-8S, click **Advanced** → **SIP Parameter** in the navigation tree and then enter voicemail User ID.

SIP Parameter

SUBSCRIBE for MWI(Message Waiting Indicator) Enable

Voicemail User ID

VoiceMail Setting in SIP Parameter

3) Set ringing time in Elastix. Elastix will prompt user to leave a message after the corresponding extension rings 15 seconds (by default). Then the Elastix sever will record the message. Related setting is shown as follows:

Voicemail

Ringtime Default:

Direct Dial Voicemail Prefix:

Direct Dial to Voicemail message type:

Optional Voicemail Recording Gain:

Do Not Play "please leave message after tone" to caller

Voicemail Setting

4) Dial *200# on the extension which is connected to DAG1000-8S, then dial voicemail user ID and enter password for authentication. After that user will hear voice message.

3.10.4 Fax Parameter

Fax Config

Fax Mode

Include "a=X-fax" Attribute Enable

Include "a=fax" Attribute Enable

Include "a=X-modem" Attribute Enable

Include "a=modem" Attribute Enable

Include "vbd" Parameter Enable

Include "silenceSupp" Parameter Enable

ECM Enable

Rate

Tone Detection by

Switch into Fax Mode When Detected CNG or CED

Figure 3.10-4 Configuration Interface for Fax Parameter

Explanation of fax parameters:

| | |
|------------------------------------|--|
| Fax Mode | There are four fax modes: T.38, T.30(Pass-through), Modem and Adaptive. |
| Include "a=X-fax" Attribute | If this parameter is enabled, "a=X-fax" attribute will be carried in SDP |
| Include "a=fax" Attribute | If this parameter is enabled, "a=fax" attribute will be carried in SDP |

| | | |
|--------------------------|--------------------|--|
| Include Attribute | “a=X-modem” | If this parameter is enabled, “a=X-modem” attribute will be carried in SDP |
| Include Attribute | “a=modem” | If this parameter is enabled, “a=modem” attribute will be carried in SDP |
| ECM | | Whether to enable ‘Error Correction Mode’. |
| Rate | | The rate of sending or receiving fax |
| Tone Detection by | | Fax sound is detected by caller, callee or automatically |

3.10.5 Digit Map

The screenshot shows a web-based configuration interface for 'Digit Map'. At the top, there is a blue header with the text 'Digit Map'. Below the header, on the left, is the text 'Match Failed(When the registration is successful)'. On the right, there is a button labeled 'Send to the server' with a small downward-pointing arrow. Below these elements is a large, empty text input field with a vertical scrollbar on the right side. The word 'any' is visible at the top left of this text area.

Figure 3.10-5 Digit Map

Digit Map Syntax

| | | |
|-------------------|-------|---|
| Supported objects | Digit | 0-9 |
| | T | Timer |
| | DTMF | A digit, a timer, or one of the symbols of A, B, C, D, #, or *. |
| Range | [] | One or more DTMF symbols enclosed in the [], but only one DTMF symbol can be selected. |

| | | |
|-----------|----|--|
| Range | () | One or more expressions enclosed the (), but only one can be selected. |
| Separator | | Separated expressions or DTMF symbols. |
| Subrange | - | Two digits separated by hyphen (-) which matches any digit between a nd including the two. |
| Wildcard | x | Matches any digit of 0 to 9 |
| Modifiers | . | Matches 0 or more times of the preceding element |
| Modifiers | ? | Matches 0 or 1 times of the preceding element |

Examples:

| | |
|------------------------|--|
| (13 15 18)xxxxxxxx | Matches the phone numbers with stating digits as 13, 15 or 18 and the left nine digits as any of 0 to 9. |
|------------------------|--|

3.10.6 Feature Codes

Please make reference to 2.7 Description of Feature Codes and the following table.

| | |
|--------------------------------------|--|
| Inquiry LAN port IP address | Dial*158# to obtain device WAN port IP address |
| Inquiry WAN port IP address | Dial*159# to obtain device WAN port IP address |
| Inquiry Phone Number | Dial*114# to obtain port account |
| Inquiry PortGroup Number | Dial *115# to obtain port group number |
| Setting IP Mode | *150*0#, means pppmodem, *150*1#, means static IP, *150*2#, means obtain IP address by DHCP, *150*3#, means PPPoE. |
| Network Work Mode | *157*0#, set network work mode to routing mode; *157*1#, set network work mode to bridge mode |
| Configure IP Address | *152*+IP, set gateway IP address |
| Network subnet mask configure | *153*+subnet mask, set gateway subnet mask |
| Network Gateway Configure | *156*+gateway IP, set gateway |

| | |
|--|--|
| Renew DHCP | *193#, set dynamic IP again |
| Access Web by Wan in Rout Mode | Allow access web through WAN port: *160*1#; don't allow access web through WAN port: *160*0# |
| Reset Basic Configuration | Dial *165*000000# to restore default username/password and network configuration |
| Reset Factory Configuration | *166*000000#, reset factory |
| Restart Device | *111#, restart device |
| Call holding | During a call, dial*# into call hold. (Recovery the call through hook flash or *#) |
| Call by IP | Directly dial the end user IP to call |
| Call Waiting Activate | *51#, enable call waiting function |
| Call Waiting Deactivate | *50#, forbid call waiting function |
| Blind Transfer | If the call transfer to 801, first hook flash and then dial the * 87 * 801# |
| Call Forward Unconditional Activate | *72*+ phone number#, transfer the call from the phone number |
| Call Forward Unconditional Deactivate | *73#, forbid call forward unconditional |
| Call Forward Busy Activate | *90*+ forward busy number# |
| Call Forward Busy Deactivate | *91#, forbid call forward busy |
| Call Forward No Reply Activate | *92*+ forward no reply number# |
| Call Forward No Reply Deactivate | *93#, close this function |
| Do Not Disturb Activate | *78#, enable DND function |
| Do Not Disturb Deactivate | *79#, close DND function |
| Dial Voicemail | *200#, visit voice mail box |

3.10.7 System Parameter

System parameters include: STUN, NTP, Provision, WEB parameter and Telnet.

1) STUN: STUN (Simple Traversal of UDP over NATs) is a lightweight protocol that allows applications to discover the presence and types of NATs and firewalls between them and the public Internet. It also provides the ability for applications to determine the IP addresses allocated to them by the NAT. STUN works with many existing NATs, and does not require any special behavior from them. STUN doesn't support TCP connection and H.323.

2) NTP: Network Time Protocol (NTP) is a computer time synchronization protocol.

3) Provision: provision is used to make the gateway automatically upgrade with the latest firmware stored on an http server an ftp server or a TFTP server.

| System Parameter | |
|------------------------------|--|
| Hint Language | English |
| NAT Traversal | Disable |
| NTP | <input checked="" type="checkbox"/> Enable |
| Primary NTP Server Address | 10.10.3.148 |
| Primary NTP Server Port | 123 |
| Secondary NTP Server Address | |
| Secondary NTP Server Port | 123 |
| SYN Interval | 3600 s |
| Time Zone | GMT+1:00 (Paris, Berlin, Rome, Brussels) |
| Daylight Saving Time | <input type="checkbox"/> Enable |
| Daily Reboot | <input type="checkbox"/> Enable |
| Reboot Time | 0 : 0 |
| Summary Config | <input type="checkbox"/> Enable |
| Summary | |
| WEB Parameter | |
| WEB Port | 80 |
| SSL Port | 443 |
| Telnet Parameter | |
| Telnet Port | 23 |
| Remote Management | |
| Access WEB by WAN | <input checked="" type="checkbox"/> Enable |
| Access WEB by LAN | <input checked="" type="checkbox"/> Enable |
| Access Telnet by WAN | <input checked="" type="checkbox"/> Enable |
| Access Telnet by LAN | <input checked="" type="checkbox"/> Enable |

Figure 3.10-7 Configuration Interface for System Parameters

Explanation for related parameters:

| | |
|-------------------------------------|---|
| Hint Language | IVR language of the gateway |
| NAT Traversal | User can choose 'Disable', 'STUN', 'static NAT' and 'dynamic NAT'. |
| NTP | To Enable or disable NTP |
| Primary NTP server address | The IP address of primary NTP server; default IP address is us.pool.ntp.org. |
| Primary NTP server port | The service port of primary NTP server; Default port is 123. |
| Secondary NTP server address | The IP address of secondary NTP server; Default IP address is 18.145.0.30 |
| Secondary NTP server port | The service port of secondary NTP server; Default port is 123 |
| SYN Interval | The interval to synchronize the time of the DAG1000-8S. Default value is 3600s. |
| Time Zone | The time zone of the gateway; Default configuration is United States central time, Chicago. |
| Daylight Saving Time | Enable or disable daylight saving time |
| Daily Reboot | Whether to enable daily reboot |
| Reboot time | The time to reboot the gateway daily |
| WEB Port | The web port of the gateway; Default port is 80 |
| Telnet port | Listening port of telnet service; Default port is 23 |
| Access WEB by WAN | Enable or disable 'Access web service from WAN' |
| Access WEB by LAN | Enable or disable 'Access web service from LAN' |
| Access Telnet by WAN | Enable or disable 'telnet service from WAN' |
| Access Telnet by LAN | Enable or disable 'telnet web service from LAN' |

3.10.8 Action URL

Action URL can be used as a means to allow the VoIP platform to learn about the DAG1000's status. It transmits data via GET request over the HTTP protocol. The DAG1000 is an HTTP client. At HTTP server side, GET request must be processed by the VoIP platform. Thus, the purpose is achieved.

| Action URL Configuration | |
|--------------------------|-----------------------------------|
| Event | Action URI |
| Startup | <input type="text"/> |
| Offhook | <input type="text"/> |
| Onhook | <input type="text"/> |
| Incoming Call | <input type="text"/> |
| Outgoing Call | <input type="text"/> |
| Call Build | <input type="text"/> |
| Call Terminate | <input type="text"/> |
| Register Status | <input type="text"/> |
| Heartbeat | <input type="text"/> |
| Heartbeat Interval | <input type="text" value="10"/> s |

Figure 3.10-8 Action URL

3.11 Call & Routing

3.11.1 Wildcard Group

| Wildcard Group | |
|-----------------|-----------------|
| Wildcarded IMPU | Associated IMPU |
| --- | --- |
| | |

Figure 3.11-1 Wildcard Group

3.11.2 Port Group

On the **Port Group** interface, user can group several ports together and then set a strategy for port selection of the group. Parameters of port group include registration, primary display name, primary SIP user id, primary authentication ID and password, secondary display name, secondary SIP user id, secondary authentication ID and password, off-hook auto dial, auto dial delay time, port select and so on.

Port Group Add

| | |
|---------------------------------|---|
| Index | <input style="width: 90%;" type="text" value="3"/> |
| Registration | <input checked="" type="checkbox"/> Enable |
| Description | <input style="width: 95%;" type="text"/> |
| Primary Display Name | <input style="width: 95%;" type="text"/> |
| Primary SIP User ID | <input style="width: 95%;" type="text"/> |
| Primary Authenticate ID | <input style="width: 95%;" type="text"/> |
| Primary Authenticate Password | <input style="width: 95%;" type="text"/> |
| Secondary Display Name | <input style="width: 95%;" type="text"/> |
| Secondary SIP User ID | <input style="width: 95%;" type="text"/> |
| Secondary Authenticate ID | <input style="width: 95%;" type="text"/> |
| Secondary Authenticate Password | <input style="width: 95%;" type="text"/> |
| Offhook Auto-Dial | <input style="width: 95%;" type="text"/> |
| Auto-Dial Delay Time | <input style="width: 95%;" type="text"/> |
| Port Select | <input style="width: 95%;" type="text" value="Cyclic Ascending"/> |
| Pick Up on Group | <input style="width: 95%;" type="text" value="*#"/> |
| Port | <input type="button" value="Click to Select Ports for this Group"/> |

Figure 3.11-2 Configuration Interface for Port group

Explanation of related parameters

| | |
|---------------------------------------|---|
| Index | The NO. of the port group ; It uniquely identifies a route, range from 0-7 |
| Description | The description of the port group; it is used to identify the port group |
| Primary/Secondary Display Name | <p>Port group display, which will be used in SIP message, for example:</p> <pre>INVITE sip:bob@biloxi.com SIP/2.0 Via: SIP/2.0/UDPpc33.atlanta.com;branch=z9hG4bK776asdhs Max-Forwards: 70 To: Bob <sip:bob@biloxi.com> From: Alice <sip:alice@atlanta.com>;tag=1928301774</pre> <p>Here Bob and Alice are the display</p> |

| | |
|--|---|
| Primary/Secondary SIP User ID | User account information, provided by VoIP service provider (ITSP). Usually in the form of digit similar to phone number or actually a phone number. |
| Primary/Secondary Authenticate ID | SIP service subscriber's authentication ID, it can be identical to or different from SIP User ID. |
| Primary/Secondary Authenticate Password | Password of SIP user ID |
| Offhook Auto-Dial | To enter offhook auto-dial number |
| Auto-dial Delay time | How long auto-dialing will be delayed |
| Port Select | <p>It specifies the policy for selecting a port for ringing in the port group</p> <ul style="list-style-type: none"> • Ascending: the gateway always selects a port from the minimum number. • Cyclic ascending: the gateway always selects a port from a number next to the number selected last time. If the maximum number was selected last time, the next selected number is the minimum number. The sequence moves in cycles like this. • Descending: the gateway always selects a port from the maximum number. • Cyclic descending: the gateway always selects a port from a number next to the number selected last time. If the minimum number was selected last time, the next selected number is the maximum number. The sequence moves in cycles like this. • Group ring: all ports ring at the same time |
| Pickup UP on group | When one port rings, user can dial '*#' to pick up the call from other ports under the same port group. |
| Port | Select ports for this port group |

3.11.3 IP Trunk

A peer-to-peer VoIP call occurs when two VoIP phones communicate directly over IP network without IP PBXs between them. IP trunk helps establish peer-to-peer call between gateway and VoIP phones. IP trunk will be used in routing configuration.

Figure 3.11-3 IP Trunk Configuration Interface

Explanation of related parameters:

| | |
|-----------------------|--|
| Index | The No. of the IP trunk; from 0 to 127 |
| Description | The description of the IP trunk; It is used to n identify the IP trunk |
| Remote Address | IP address or domain name of peer device |
| Remote Port | SIP port of peer device |
| Heartbeat | Whether to enable the 'Heartbeat' function for the IP trunk. Default value is ' not enable'. If heartbeat is enabled, the gateway will send "OPTION" to peer device. |

3.11.4 Routing Parameter

This parameter determines a call is routed before or after manipulation.

Figure 3.11-4 Configuration Interface for Routing Parameter

3.11.5 IP -> Tel Routing

IP->Tel Routing Add

| | |
|---------------|--|
| Index | <input style="width: 95%;" type="text" value="127"/> |
| Description | <input style="width: 95%;" type="text"/> |
| Calls from | <input type="radio"/> IP Trunk <input style="width: 100px;" type="text" value="Any"/> |
| | <input checked="" type="radio"/> SIP Server |
| Caller Prefix | <input style="width: 95%;" type="text"/> |
| Callee Prefix | <input style="width: 95%;" type="text"/> |
| Calls to | <input type="radio"/> Port <input style="width: 50px;" type="text" value="0"/> |
| | <input checked="" type="radio"/> Port Group <input style="width: 100px;" type="text"/> |

Figure 3.11-5 Configuration Interface for IP-Tel Routing

Explanation of related parameters:

| | |
|----------------------|--|
| Index | IP →Routing priority: from 0 to127; 0 is the highest priority. |
| Description | It is used to identify the IP → routing |
| Calls from | IP Trunk or SIP Server; ‘any’ means any IP addresses |
| Caller Prefix | The prefix of the caller number, which helps match routing exactly. its length is less than or equal to the caller number. For example, if caller number is 2001, the caller prefix can be 200 or 2. ‘any’ means the prefix matches any caller number. |
| Callee Prefix | The prefix of the called number, which helps match routing exactly. Its length is less than or equal to the called number. If the called number is 008675526456659, the called prefix can be 0086755 or 00. “any” means the prefix matches any called number |
| Calls to | Which port or port group to which calls are routed |

3.11.6 Tel-IP/Tel Routing

Tel->IP/Tel Routing Add

| | |
|---------------|--|
| Index | <input style="width: 95%;" type="text" value="127"/> |
| Description | <input style="width: 95%;" type="text"/> |
| Calls from | <input checked="" type="radio"/> Port <input style="width: 50%;" type="text" value="0"/> |
| | <input type="radio"/> Port Group <input style="width: 50%;" type="text"/> |
| Caller Prefix | <input style="width: 95%;" type="text"/> |
| Callee Prefix | <input style="width: 95%;" type="text"/> |
| Calls to | <input type="radio"/> Port <input style="width: 50%;" type="text" value="0"/> |
| | <input type="radio"/> Port Group <input style="width: 50%;" type="text"/> |
| | <input type="radio"/> IP Trunk <input style="width: 50%;" type="text"/> |
| | <input checked="" type="radio"/> SIP Server |

Figure 3.11-6 Configuration Interface for Tel-IP/Tel Routing

Explanation of related parameters:

| | |
|----------------------|---|
| Index | The index of this Tel →IP/Tel routing, from 0 to 127. Each index cannot be used repeatedly. Routing priority: 0 is the highest priority. |
| Description | It is used to identify the routing |
| Calls From | Tel →IP calls are from a port or a port group |
| Caller Prefix | The prefix of the caller number, which helps match routing exactly. its length is less than or equal to the caller number. For example, if caller number is 2001, the caller prefix can be 200 or 2. 'any' means the prefix matches any caller number. |
| Callee Prefix | The prefix of the called number, which helps match routing exactly. Its length is less than or equal to the called number. If the called number is 008675526456659, the called prefix can be 0086755 or 00. "any" means the prefix matches any called number. |
| Calls to | Calls are routed to a port, port group, IP trunk or SIP server |

3.11.7 IP – IP Routing

IP->IP Routing Add

| | |
|---------------|---|
| Index | <input style="width: 95%;" type="text" value="127"/> |
| Description | <input style="width: 95%;" type="text"/> |
| Calls from | <input type="radio"/> IP Trunk <input style="width: 80%;" type="text" value="Any"/> |
| Caller Prefix | <input style="width: 95%;" type="text"/> |
| Callee Prefix | <input style="width: 95%;" type="text"/> |
| Calls to | <input type="radio"/> IP Trunk <input style="width: 80%;" type="text"/> |

Figure 3.11-7 Configuration Interface for IP->IP Routing

Explanation of related parameters:

| | |
|----------------------|---|
| Index | The index of this IP → IP routing, from 0 to 127. Each index cannot be used repeatedly. Routing priority: 0 is the highest priority. |
| Description | It is used to identify the routing |
| Calls From | Calls are from IP trunk. |
| Caller Prefix | The prefix of the caller number, which helps match routing exactly. its length is less than or equal to the caller number. For example, if caller number is 2001, the caller prefix can be 200 or 2. 'any' means the prefix matches any caller number. |
| Callee Prefix | The prefix of the called number, which helps match routing exactly. Its length is less than or equal to the called number. If the called number is 008675526456659, the called prefix can be 0086755 or 00. "any" means the prefix matches any called number. |
| Calls to | Calls are routed to IP trunk |

3.12 Manipulation Configuration

Number manipulation refers to the change of a called number or a caller number during calling process when the called number or the caller number matches the preset rules.

3.12.1 IP -> Tel Callee

IP->Tel Callee Add

| | |
|--------------------------------------|--|
| Index | <input style="width: 90%;" type="text" value="127"/> |
| Description | <input style="width: 90%;" type="text"/> |
| Calls from | <input type="radio"/> IP Trunk <input style="width: 80%;" type="text" value="Any"/> |
| | <input checked="" type="radio"/> SIP Server |
| Caller Prefix | <input style="width: 90%;" type="text"/> |
| Callee Prefix | <input style="width: 90%;" type="text"/> |
| Calls to | <input checked="" type="radio"/> Port <input style="width: 80%;" type="text" value="0"/> |
| | <input type="radio"/> Port Group <input style="width: 80%;" type="text"/> |
| Stripped Digits from Left | <input style="width: 90%;" type="text"/> |
| Stripped Digits from Right | <input style="width: 90%;" type="text"/> |
| Prefix to Add | <input style="width: 90%;" type="text"/> |
| Suffix to Add | <input style="width: 90%;" type="text"/> |
| Number of Digits to Leave from Right | <input style="width: 90%;" type="text"/> |

Figure 3.12-1 Add IP -> IP Callee

| | |
|----------------------|--|
| Index | The index of this manipulation, from 0 to 127. Each index cannot be used repeatedly. 0 is the highest priority |
| Description | Name of this IP ->Tel manipulation name |
| Calls From | Determine the calls come from IP trunk or SIP server |
| Caller Prefix | Set a prefix for caller number. The prefix's length is less than or equal to that of the caller number, which helps to match routing. If caller number is 2001, the caller prefix can be 200 or 2. "any" means match any caller number. |
| Callee Prefix | Set a prefix for called number. The prefix's length is less than or equal to called number, which helps to match routing. If called number is 008675526456659, the called prefix can be 0086755 or 00. "any" means match any called number |
| Calls to | Determine the port or port group to which the call is routed. |

| | |
|---|--|
| Stripped Digits from Left | The number of digits which are lessened from the left of the callee number |
| Stripped Digits from Right | The number of digits which are lessened from the right of the callee number |
| Prefix to Add | The prefix added to the callee number after its digits are lessened. |
| Suffix to Add | The suffix added to the callee number after its digits are lessened. |
| Number of Digits to Leave from Right | The number of the retained digits which. are counted from the right of the callee number |

3.12.2 Tel -> IP/Tel Caller

Tel->IP/Tel Caller Add

| | |
|--------------------------------------|---|
| Index | <input style="width: 90%;" type="text" value="127"/> |
| Description | <input style="width: 90%;" type="text"/> |
| Calls from | <input checked="" type="radio"/> Port <input style="width: 50px;" type="text" value="0"/> <input type="radio"/> Port Group <input style="width: 50px;" type="text"/> |
| Caller Prefix | <input style="width: 90%;" type="text"/> |
| Callee Prefix | <input style="width: 90%;" type="text"/> |
| Calls to | <input type="radio"/> Port <input style="width: 50px;" type="text" value="0"/> <input type="radio"/> Port Group <input style="width: 50px;" type="text"/> <input type="radio"/> IP Trunk <input style="width: 50px;" type="text" value="Any"/> <input checked="" type="radio"/> SIP Server |
| Stripped Digits from Left | <input style="width: 90%;" type="text"/> |
| Stripped Digits from Right | <input style="width: 90%;" type="text"/> |
| Prefix to Add | <input style="width: 90%;" type="text"/> |
| Suffix to Add | <input style="width: 90%;" type="text"/> |
| Number of Digits to Leave from Right | <input style="width: 90%;" type="text"/> |

Figure 3.12-2 Add Tel -> IP Caller

Configuration parameters are the same with those of 'IP->Tel Callee'.

3.12.3 Tel-IP/Tel Callee

Tel->IP/Tel Callee Add

| | |
|--------------------------------------|--|
| Index | 127 ▼ |
| Description | |
| Calls from | <input checked="" type="radio"/> Port 0 ▼ |
| | <input type="radio"/> Port Group ▼ |
| Caller Prefix | |
| Callee Prefix | |
| Calls to | <input type="radio"/> Port 0 ▼ |
| | <input type="radio"/> Port Group ▼ |
| | <input type="radio"/> IP Trunk Any ▼ |
| | <input checked="" type="radio"/> SIP Server |
| Stripped Digits from Left | |
| Stripped Digits from Right | |
| Prefix to Add | |
| Suffix to Add | |
| Number of Digits to Leave from Right | |

Figure 3.12-3 Add Tel-IP Callee

Configuration parameters are the same with those of 'Tel->IP Caller'.

3.13 Routing rule examples

3.13.1 Route any calls from any IP to specific port

After enter the Web interface, click **Call & Routing** → **IP-Tel Routing** in the navigation tree on the left, and then click **Add** to create a new routing rule.

IP->Tel Routing Add

| | | |
|---------------|--|---|
| Index | <input style="width: 90%;" type="text" value="127"/> | |
| Description | <input style="width: 90%;" type="text" value="any"/> | |
| Calls from | <input checked="" type="radio"/> IP Trunk <input style="width: 100px;" type="text" value="Any"/> | <input type="radio"/> SIP Server |
| Caller Prefix | <input style="width: 90%;" type="text" value="any"/> | |
| Callee Prefix | <input style="width: 90%;" type="text" value="any"/> | |
| Calls to | <input checked="" type="radio"/> Port <input style="width: 100px;" type="text" value="0"/> | <input type="radio"/> Port Group <input style="width: 100px;" type="text"/> |

NOTES:

1. 'any' in 'Callee Prefix' or 'Caller Prefix' means wildcard string.

In the example above, all calls will be routed to port 0 when the routing rule is matched.

3.13.2 Route any calls from any IP to specified port group

► Create port group

Before we can route calls to a port group, create the port group first as below. On the **Call & Routing** → **Port Group**, click **Add** to create a new port group.

Port Group Add

| | |
|-------|--|
| Index | <input style="width: 90%;" type="text" value="7"/> |
|-------|--|

Select Port for this Group

| | | | |
|---|---|---|---|
| <input checked="" type="checkbox"/> Port 0(FXS) | <input checked="" type="checkbox"/> Port 1(FXS) | <input type="checkbox"/> Port 2(FXS) | <input type="checkbox"/> Port 3(FXS) |
| <input type="checkbox"/> Port 4(FXS) | <input checked="" type="checkbox"/> Port 5(FXS) | <input checked="" type="checkbox"/> Port 6(FXS) | <input checked="" type="checkbox"/> Port 7(FXS) |

Port 0, port 1, port 5, port 6 and port7 are assigned to port group 7.

►Route any calls to the port group

On the **Call & Routing** → **IP-Tel Routing** interface, click **Add** to create a new routing rule.

IP->Tel Routing Add

| | |
|---------------|---|
| Index | <input style="width: 90%;" type="text" value="127"/> |
| Description | <input style="width: 90%;" type="text" value="any to port group"/> |
| Calls from | <input checked="" type="radio"/> IP Trunk <input style="width: 80%;" type="text" value="Any"/> |
| | <input type="radio"/> SIP Server |
| Caller Prefix | <input style="width: 90%;" type="text" value="any"/> |
| Callee Prefix | <input style="width: 90%;" type="text" value="any"/> |
| Calls to | <input type="radio"/> Port <input style="width: 80%;" type="text" value="0"/> |
| | <input checked="" type="radio"/> Port Group <input style="width: 80%;" type="text" value="7 <port group 1>"/> |

NOTES:

1. 'any' in 'Callee Prefix' or 'Caller Prefix' means wildcard string.

As shown above, if the routing rule is matched, calls will be routed to port group 7.

3.13.3 Route any calls from any port to specific SIP IP trunk

Create IP Trunk on the **Call & Routing** → **IP Trunk** interface:

IP Trunk Add

| | |
|----------------|---|
| Index | <input style="width: 90%;" type="text" value="127"/> |
| Description | <input style="width: 90%;" type="text" value="To_Elastix"/> |
| Remote Address | <input style="width: 90%;" type="text" value="172.16.125.125"/> |
| Remote Port | <input style="width: 90%;" type="text" value="5060"/> |
| Heartbeat | <input type="checkbox"/> Enable |

After IP Trunk is created, check the following configuration:

| IP Trunk | | | | | |
|--------------------------|-------|-------------|----------------|-------------|-----------|
| | Index | Description | Remote Address | Remote Port | Heartbeat |
| <input type="checkbox"/> | 127 | To_Elastix | 172.16.125.125 | 5060 | Disable |

Total: 1 entry Page 1 ▼

As shown above, the IP trunk is created, and the remote end IP address is 172.16.125.125, the SIP port is 5060.

Create Tel -> IP routing rule

On the **Call & Routing** → **Tel-IP Routing** interface, click “Add” to create a new Tel → IP routing rule.

Tel->IP/Tel Routing Add

| | | |
|---------------|--|---|
| Index | <input style="width: 90%;" type="text" value="127"/> | |
| Description | <input style="width: 90%;" type="text" value="Tel to IP trunk"/> | |
| Calls from | <input checked="" type="radio"/> Port | <input style="width: 80%;" type="text" value="Any"/> |
| | <input type="radio"/> Port Group | <input style="width: 80%;" type="text" value="7 <port group 1>"/> |
| Caller Prefix | <input style="width: 90%;" type="text" value="any"/> | |
| Callee Prefix | <input style="width: 90%;" type="text" value="any"/> | |
| Calls to | <input type="radio"/> Port | <input style="width: 80%;" type="text" value="0"/> |
| | <input type="radio"/> Port Group | <input style="width: 80%;" type="text" value="7 <port group 1>"/> |
| | <input checked="" type="radio"/> IP Trunk | <input style="width: 80%;" type="text" value="127 <To_Elastix>"/> |
| | <input type="radio"/> SIP Server | |

NOTES:

- 'any' in 'Callee Prefix' or 'Caller Prefix' means wildcard string.

All Tel calls from any caller number to any called number will be routed to IP trunk 127.

3.14 Maintenance

3.14.1 TR069

ACS URL (auto-configuration server URL address) is provided by service provider. The ACS URL generally starts with http:// or https://

Username and password are used for ACS authentication.

| | |
|--------------------------|--|
| TR069 | <input checked="" type="checkbox"/> Enable |
| ACS Configuration | |
| ACS URL | <input type="text"/> |
| User Name | <input type="text"/> |
| Password | <input type="text"/> |
| Periodic Inform | <input checked="" type="checkbox"/> Enable |
| Periodic Inform Interval | <input type="text" value="30"/> s |
| Connect Request | |
| User Name | <input type="text"/> |
| Password | <input type="text"/> |
| Port | <input type="text" value="8099"/> |

Figure 3.14-1 TR069 Parameters

3.14.2 SNMP (Simple Network Management Protocol)

SNMP Parameters:

- SNMP enable: to disable or enable the SNMP feature
- SNMP version: the DAG1000-8S gateway supports SNMP v1 and v2
- Community: the community name used to read through SNMP protocol
- Source: the IP address of SNMP server

SNMP Parameter

Snmp Enable

Snmp Version v1

Community Configuration

| | Community | Source |
|-----|--|--|
| 1st | <input style="width: 95%;" type="text"/> | <input style="width: 95%;" type="text"/> |
| 2nd | <input style="width: 95%;" type="text"/> | <input style="width: 95%;" type="text"/> |
| 3rd | <input style="width: 95%;" type="text"/> | <input style="width: 95%;" type="text"/> |

Note: Value of 'Source' is 'default' or IP Address(eg:192.168.1.1)!

Group Configuration

| | Group | Community |
|-----|--|--|
| 1st | <input style="width: 95%;" type="text"/> | ▼ |
| 2nd | <input style="width: 95%;" type="text"/> | ▼ |
| 3rd | <input style="width: 95%;" type="text"/> | ▼ |

View Configuration

| | ViewName | ViewType | ViewSubtree | ViewMask |
|-----|--|--|--|--|
| 1st | <input style="width: 95%;" type="text"/> | ▼ | <input style="width: 95%;" type="text"/> | <input style="width: 95%;" type="text"/> |
| 2nd | <input style="width: 95%;" type="text"/> | ▼ | <input style="width: 95%;" type="text"/> | <input style="width: 95%;" type="text"/> |
| 3rd | <input style="width: 95%;" type="text"/> | ▼ | <input style="width: 95%;" type="text"/> | <input style="width: 95%;" type="text"/> |

Note: Value style of 'ViewSubtree' is 'x.x.x.x.x'(multi-nodes) or '.x'(one node).

Access Configuration(v1/v2c)

| | Group | Read | Write | Notify |
|-----|--|--|--|--|
| 1st | ▼ | ▼ | ▼ | ▼ |
| 2nd | ▼ | ▼ | ▼ | ▼ |
| 3rd | ▼ | ▼ | ▼ | ▼ |

Note: The value of Read/Write/Notify references to 'ViewName' in View Configuration. Access Configuration is base on Group Configuration and View Configuration.

Trap Configuration

| | Trap Type | Trap IP | Trap Port | Trap Community |
|-----|--|--|--|--|
| 1st | ▼ | <input style="width: 95%;" type="text"/> | <input style="width: 95%;" type="text"/> | <input style="width: 95%;" type="text"/> |

Figure 3.14-2 SNMP Parameters

User configuration is only available on SNMP v3.

SNMP Version

User Configuration

| | User | AuthType | AuthPassword | PrivacyType | PrivacyPassword |
|-----|----------------------|----------------------|----------------------|----------------------|----------------------|
| 1st | <input type="text"/> | <input type="text"/> | <input type="text"/> | <input type="text"/> | <input type="text"/> |

Notice: The length of AuthPassword and PrivacyPassword are more than 8!

Group configuration

Group: community group name which consist of character string.

Community: let community join the community group which configured above

Group Configuration

| | Group | Community |
|-----|--|-------------------------------------|
| 1st | <input type="text" value="grouppublic"/> | <input type="text" value="public"/> |
| 2nd | <input type="text"/> | <input type="text"/> |
| 3rd | <input type="text"/> | <input type="text"/> |

Trap configuration

Trap configuration enable to configure Trap server IP and port. This setting available for SNMP v2c and v1.

Trap Configuration

| | TrapFlag | TrapIP | TrapPort | TrapCommunity |
|-----|----------------------------------|--|----------------------------------|-------------------------------------|
| 1st | <input type="text" value="v2c"/> | <input type="text" value="172.16.22.222"/> | <input type="text" value="162"/> | <input type="text" value="public"/> |

3.14.3 Syslog

Syslog is a standard for network device data logging. It allows separation of the software that generates messages from the system that stores them and the software that reports and analyzes them. It also provides devices which would otherwise be unable to communicate a means to notify administrators of problems or performance. There are 5 levels of syslog, Including NONE, DEBUG, NOTICE, WARNING and ERROR.

The Signal Log is included following traces which defined in system by default

- SD, hardware debug
- SIP, SIP signaling trace
- STUN, STUN logs
- ECC, detail information of call control module

- *RE, the common communication module for SCP and SIM*
- *SCP, the communication protocol between gateway and cloud server*

The media log is included following traces which defined in system by default

- *RTP, RTP stream info collection*
- *SIM, to output traces between gateway and remote SIM cards*

The System Log is included following traces which mainly used by developer

- *SYS, system log*
- *TIMER, system process*
- *TASK, system task process*
- *CFM, system process*
- *NTP*

The Management Log is included following traces which defined in system by default

- *CLI, command line*
- *TEL,*
- *LOAD, firmware upload*
- *SNMP*
- *WEBS, embedded web server*
- *PROV, provisioning*

Server Syslog:

When the gateway registers to Cloud server, the option will be changed to un-configurable and all logs to be storage on server.

| Syslog Parameter | |
|------------------|--|
| Local Syslog | <input checked="" type="checkbox"/> Enable |
| Server Address | <input type="text"/> |
| Server Port | <input type="text" value="514"/> |
| Syslog Level | <input type="text" value=""/> |
| Signal Log | <input type="checkbox"/> Enable |
| Media Log | <input type="checkbox"/> Enable |
| System Log | <input type="checkbox"/> Enable |
| Management Log | <input type="checkbox"/> Enable |
| CDR | <input type="checkbox"/> Enable |
| Server Syslog | <input type="checkbox"/> Enable |

Figure 3.14-3 Syslog Parameter

Enable send CDR, and then send communication information to syslog server.

3.14.4 Provision

Provision is used to make the DAG1000-8S automatically upgrade with the latest firmware stored on an http server an FTP server or a TFTP server.

| Provision | |
|--|---------------------------------|
| URL | <input type="text"/> |
| Check Interval | <input type="text" value=""/> s |
| Account | <input type="text"/> |
| Password | <input type="text"/> |
| Proxy Domain | <input type="text"/> |
| Proxy Port | <input type="text"/> |
| Proxy Account | <input type="text"/> |
| Proxy Password | <input type="text"/> |
| Install updates automatically(recommended) | <input type="checkbox"/> Enable |

Figure 3.14-4 Provision

| | |
|-----------------------|--|
| URL | Provisioning server URL, support HTTP, TFTP, FTP |
| Check Interval | The interval to check the changes on the provisioning server |
| Account | Account for login provisioning server |
| Password | Account for login provisioning server |

3.14.5 Cloud server

User can register the gateway to cloud server, and then the gateway will be managed by cloud server.

Cloud Server

Server Address

Port

Domain

Join the remote management system **Enable**

Figure 3.14-5 Cloud Server

Explanation of related parameters

| | |
|-----------------------|--|
| Server Address | The IP address or domain of the cloud server |
| port | The listening port of the cloud server |
| Password | Password for register with cloud server |

3.15 Security

3.15.1 WEB ACL

ACL (Access Control List) for WEB is used to configure IP addresses (users) that are allowed to access the WEB page of the gateway. The IP address list can't be null once ACL is enabled.

The screenshot shows a web interface titled "ACL" with a sub-section "ACL for WEB:". On the right side of this section, there is an "Enable" checkbox which is currently unchecked. Below the "Enable" checkbox is a large, empty rectangular list box. To the right of the bottom of this list box are two buttons: "Delete" and "Add". Below the list box is a horizontal input field for adding new entries.

Figure 3.15-1 ACL for WEB

3.15.2 Telnet ACL

ACL (Access Control List) for WEB is used to configure IP addresses (users) that are allowed to access the Telnet page of the gateway. The IP address list can't be null once ACL is enabled.

The screenshot shows a web interface titled "ACL for Telnet". On the right side of this section, there is an "Enable" checkbox which is currently unchecked. Below the "Enable" checkbox is a large, empty rectangular list box. To the right of the bottom of this list box are two buttons: "Delete" and "Add". Below the list box is a horizontal input field for adding new entries.

Figure 3.15-2 ACL for Telnet

3.15.3 Passwords

On the following interface user can configure or modify the username and password for access the WEB interface and the Telnet interface.

Note: Both the username and password of Web and Telnet are 'admin' and 'admin'.

| Password Modification | |
|-------------------------|------------------------------------|
| Web Config | |
| Old Web Username | <input type="text" value="admin"/> |
| Old Web Password | <input type="text"/> |
| New Web Username | <input type="text"/> |
| New Web Password | <input type="text"/> |
| Confirm Web Password | <input type="text"/> |
| Telnet Config | |
| Old Telnet Username | <input type="text" value="admin"/> |
| Old Telnet Password | <input type="text"/> |
| New Telnet Username | <input type="text"/> |
| New Telnet Password | <input type="text"/> |
| Confirm Telnet Password | <input type="text"/> |

Figure 3.15-3 Password Modification

3.16 Tools

3.16.1 Firmware upload

Firmware upload steps:

Step 1.

Check the current firmware version on the **System Information page**

| | |
|--------------------------|---|
| Current Software Version | IAD-8S 1.18.02.20 PCB 0 LOGIC 0 BIOS 1, 2016-01-29 11:56:23 |
| Backup Software Version | IAD-8S 2.18.02.20 PCB 0 LOGIC 0 BIOS 1, 2016-01-29 11:55:43 |
| DSP Version | C64V_7_8_3 |
| U-BOOT Version | 9 |
| Kernel Version | 14 |
| FS Version | 2.0.15 |
| Hint Language | English |

Figure 3.16-1 Firmware Version

Step 2.

Prepare firmware package. The most important is that the package must match with the existing version. Package version consists of the following parts:

1.18.xx.xx

01/02 is vendor name

18 is hardware version, xx.xx is version number

Step 3.

Upload firmware, select the package from specific folder on the computer and click **Upload** button.

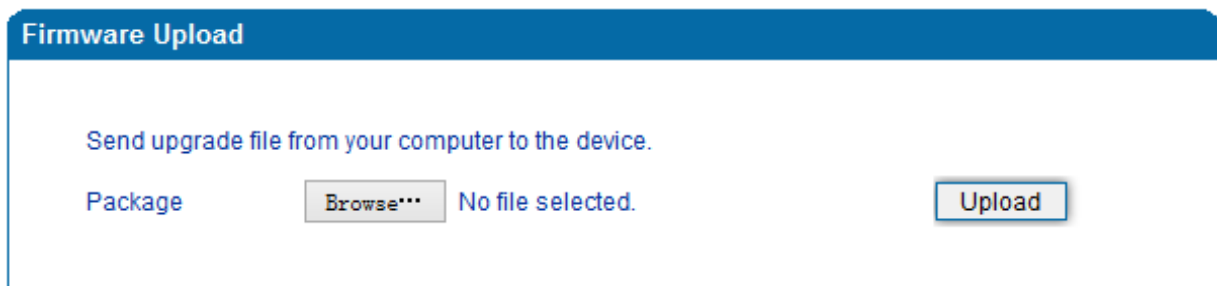

Firmware Upload

Send upgrade file from your computer to the device.

Package No file selected.

Figure 3.16-2 Firmware Upload

Step 4.

Keep waiting until it prompts 'Software loaded successfully!'

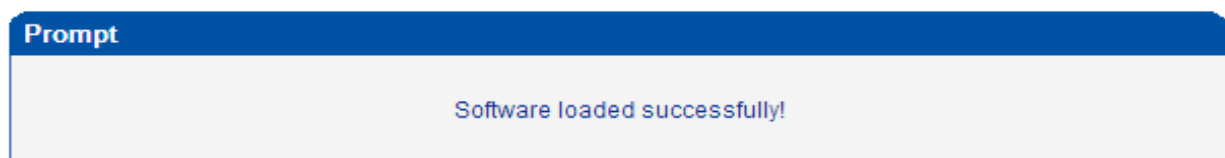

Prompt

Software loaded successfully!

Figure 3.16-3 Successful Firmware Upload

Step 5.

Reboot gateway. Refer to web page **Maintenance-> Device Restart**

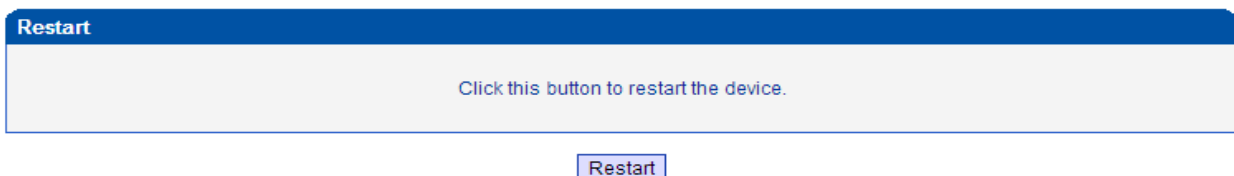

Restart

Click this button to restart the device.

Figure 3.16-4 Restart Gateway

3.16.2 Data Backup

The process data backup:

- 1) Click "Data Backup"
- 2) Click "Backup" to backup data to PC.

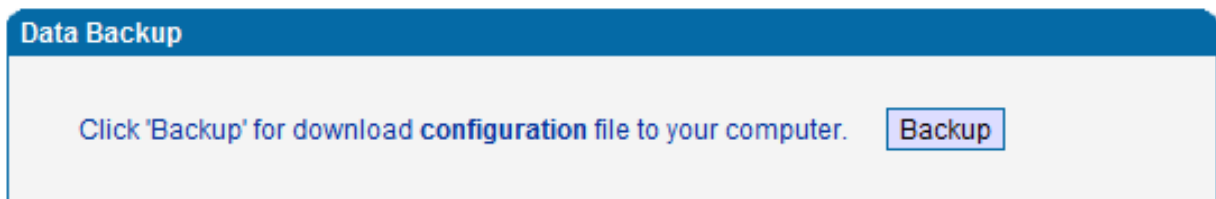

Figure 3.16-5 Data Backup

3.16.3 Data Restore

The processes of data restore:

- ▶ Click 'Data Restore';
- ▶ Browse file, select data file.
- ▶ Click 'Restore' and then import successfully, the device will restart automatically.

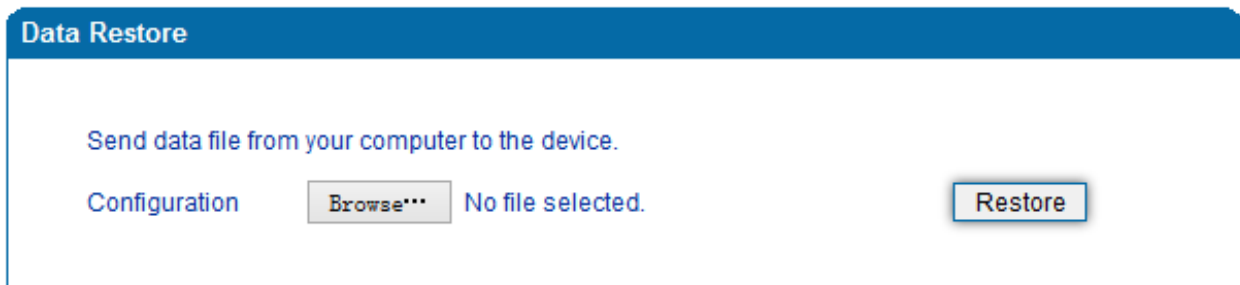

Figure 3.16-6 Data Restore

3.16.4 Ping Test

On the **Tools** → **Ping Test** interface, user can use Ping to check whether the network is working or not.

Ping instructions:

- 1) Click 'Tools → Ping Test' on the navigation tree on the left;
- 2) Fill in IP address or domain whose connection needs to be checked, click **start**.

If a message is received, it indicates that network connection is normal. Otherwise, the network connection is down.

Ping Test

Destination

Number of Ping(1-100)

Packet Size(56-1024 bytes)

Information

```
Pinging www.google.com[Resolve: 173.194.127.240] with
56 bytes of data:
Reply seq=0 from 173.194.127.240: bytes=56 time=20ms
TTL=54
```

Figure 3.16-7 Ping Test

3.16.5 Tracert Test

Tracert is a trace router used to track routing.

Tracert sends a sequence of Internet Control Message Protocol (ICMP) echo request packets addressed to a destination host. Determining the intermediate routers traversed involves adjusting the time-to-live (TTL), aka hop limit, Internet Protocol parameter. Frequently starting with a value like 128 (Windows) or 64 (Linux), routers decrement this and discard a packet when the TTL value has reached zero, returning the ICMP error message ICMP Time Exceeded.

Tracert works by increasing the TTL value of each successive set of packets sent. The first set of packets sent have a hop limit value of 1, expecting that they are not forwarded by the first router. The next set have a hop limit value of 2, so that the second router will send the error reply. This continues until the destination host receives the packets and returns an ICMP Echo Reply message.

Trace route uses the returned ICMP messages to produce a list of hops (which usually consists of routers and layer 3 switches) that the packets have traversed. The timestamp values returned for each router along the path are the delay (aka latency) values, typically measured in milliseconds for each packet.

Tracert introduce:

- ▶ Click 'Tracert Test' in the navigation tree;
- ▶ Fill in IP address or domain whose route needs to be tracked, and then click **start**.

Tracert Test

Destination

Max Hops(1-255)

Information

```

Tracing route to www.google.com[Resolve:
173.194.127.240] over a maximum of 30 hops:
 0  10 ms  172.16.1.1
 1  1 ms   113.106.38.109
 2  *     Request timed out.
 3  10 ms  121.34.242.234
 4  10 ms  202.97.33.242
 5  10 ms  202.97.60.50
 6  *     Request timed out.
 7  *     Request timed out.
 8  *     Request timed out.
          
```

Figure 3.16-8 Tracert Test

3.16.6 Outward Test

Outward test enables users to diagnose the physical phone lines which follow GR909 standards. To start outward test, select the ports to be tested and click 'start'. Testing costs a few minutes.

Outward Test

| Port | Enable | Loop Open | H.F. DC Voltage(V) | H.F. AC Voltage(mV) | Tip/Ring Short | Result |
|------|--------------------------|-----------|--------------------|---------------------|----------------|--------|
| 0 | <input type="checkbox"/> | | | | | |
| 1 | <input type="checkbox"/> | | | | | |
| 2 | <input type="checkbox"/> | | | | | |
| 3 | <input type="checkbox"/> | | | | | |
| 4 | <input type="checkbox"/> | | | | | |
| 5 | <input type="checkbox"/> | | | | | |
| 6 | <input type="checkbox"/> | | | | | |
| 7 | <input type="checkbox"/> | | | | | |

Options:

Test All Ports

Figure 3.16-9 Outward Test

Test results

OK: the analog phone set and phone line are working well

FAIL: analog phone doesn't connect to FXS port or there's something wrong in phone set

3.16.7 Network Capture

Network capture is a very important diagnostic tool for maintenance. It can be used to capture data packages of the available network ports.

Default Setting is PCM capture

PCM capture helps to analysis voice stream between analog phone and DSP chipset.

► To enable PCM capture

- ◆ Select 'PCM' on Network Capture page

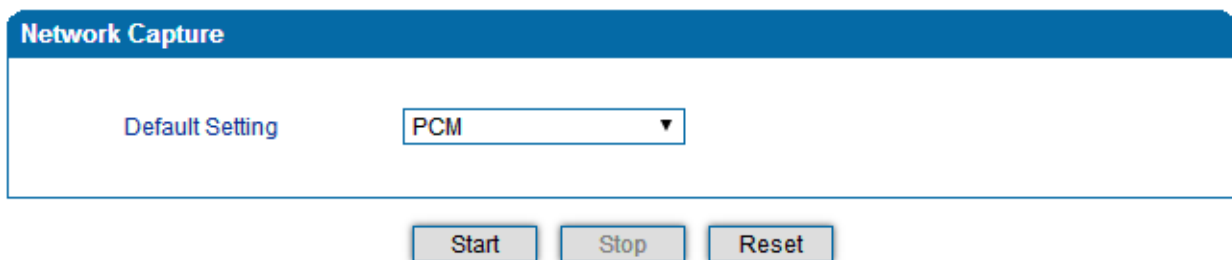

The screenshot shows a web interface for 'Network Capture'. It features a blue header bar with the text 'Network Capture'. Below this, there is a section with a 'Default Setting' label and a dropdown menu set to 'PCM'. At the bottom of this section, there are three buttons: 'Start', 'Stop', and 'Reset'.

- ◆ Click "Start" to enable PCM capture
- ◆ Dialing out through gateway, start talking a short while then hangup the call.
- ◆ Click "Stop" to disable network capture
- ◆ Save the capture file to local computer

The capture is named to 'capture(x).pcap', x is serial number of capture and will be added 1 in next time. The sample of PCM capture as below:

| No. | Time | Source | Destination | Protocol | Length | Info | |
|-----|----------|-------------------|-------------------|------------|--------|-------------------------------|---------------------------------|
| 1 | 0.000000 | Motorola_1c:1d:1e | Cimsys_33:44:55 | CSM_ENCABS | 104 | --> 0x0021 | Ch: 0xFFFF, Seq: 8 (From Host) |
| 2 | 0.000131 | Cimsys_33:44:55 | Motorola_1c:1d:1e | Ethernet | 20 | Ethernet II[Malformed Packet] | |
| 3 | 0.000245 | Cimsys_33:44:55 | Motorola_1c:1d:1e | CSM_ENCABS | 44 | --> 0x0021 | Ch: 0xFFFF, Seq: 11 (From Host) |
| 4 | 1.320893 | Motorola_1c:1d:1e | Cimsys_33:44:55 | CSM_ENCABS | 104 | --> 0x0000 | Ch: 0x0003, Seq: 0 (From Host) |
| 5 | 1.321022 | Cimsys_33:44:55 | Motorola_1c:1d:1e | Ethernet | 20 | Ethernet II[Malformed Packet] | |
| 6 | 1.321129 | Cimsys_33:44:55 | Motorola_1c:1d:1e | CSM_ENCABS | 30 | --> 0x0000 | Ch: 0x0003, Seq: 1 (From Host) |
| 7 | 1.329890 | Motorola_1c:1d:1e | Cimsys_33:44:55 | CSM_ENCABS | 104 | --> 0x0e01 | Ch: 0x0003, Seq: 1 (From Host) |
| 8 | 1.330010 | Cimsys_33:44:55 | Motorola_1c:1d:1e | Ethernet | 20 | Ethernet II[Malformed Packet] | |
| 9 | 1.330093 | Cimsys_33:44:55 | Motorola_1c:1d:1e | CSM_ENCABS | 30 | --> 0x0e01 | Ch: 0x0003, Seq: 2 (From Host) |
| 10 | 1.330472 | Motorola_1c:1d:1e | Cimsys_33:44:55 | CSM_ENCABS | 104 | --> 0x0802 | Ch: 0x0003, Seq: 2 (From Host) |
| 11 | 1.330566 | Cimsys_33:44:55 | Motorola_1c:1d:1e | Ethernet | 20 | Ethernet II[Malformed Packet] | |
| 12 | 1.330639 | Cimsys_33:44:55 | Motorola_1c:1d:1e | CSM_ENCABS | 30 | --> 0x0802 | Ch: 0x0003, Seq: 3 (From Host) |
| 13 | 1.330820 | Motorola_1c:1d:1e | Cimsys_33:44:55 | CSM_ENCABS | 104 | --> 0x0803 | Ch: 0x0003, Seq: 3 (From Host) |
| 14 | 1.330903 | Cimsys_33:44:55 | Motorola_1c:1d:1e | Ethernet | 20 | Ethernet II[Malformed Packet] | |
| 15 | 1.330989 | Cimsys_33:44:55 | Motorola_1c:1d:1e | CSM_ENCABS | 30 | --> 0x0803 | Ch: 0x0003, Seq: 4 (From Host) |
| 16 | 1.337791 | Motorola_1c:1d:1e | Cimsys_33:44:55 | CSM_ENCABS | 104 | --> 0x9010 | Ch: 0x0003, Seq: 4 (From Host) |
| 17 | 1.337996 | Cimsys_33:44:55 | Motorola_1c:1d:1e | Ethernet | 20 | Ethernet II[Malformed Packet] | |
| 18 | 1.338033 | Cimsys_33:44:55 | Motorola_1c:1d:1e | CSM_ENCABS | 30 | << 0x9010 | Ch: 0x0003, Seq: 5 (To Host) |
| 19 | 1.338369 | Motorola_1c:1d:1e | Cimsys_33:44:55 | CSM_ENCABS | 104 | --> 0x9000 | Ch: 0x0003, Seq: 5 (From Host) |
| 20 | 1.338460 | Cimsys_33:44:55 | Motorola_1c:1d:1e | Ethernet | 20 | Ethernet II[Malformed Packet] | |
| 21 | 1.338564 | Cimsys_33:44:55 | Motorola_1c:1d:1e | CSM_ENCABS | 30 | << 0x9000 | Ch: 0x0003, Seq: 6 (To Host) |
| 22 | 1.343521 | Motorola_1c:1d:1e | Cimsys_33:44:55 | CSM_ENCABS | 104 | --> 0x8084 | Ch: 0x0003, Seq: 6 (From Host) |
| 23 | 1.343627 | Cimsys_33:44:55 | Motorola_1c:1d:1e | Ethernet | 20 | Ethernet II[Malformed Packet] | |
| 24 | 1.343725 | Cimsys_33:44:55 | Motorola_1c:1d:1e | CSM_ENCABS | 30 | << 0x8084 | Ch: 0x0003, Seq: 7 (To Host) |
| 25 | 1.344060 | Motorola_1c:1d:1e | Cimsys_33:44:55 | CSM_ENCABS | 104 | --> 0x8001 | Ch: 0x0003, Seq: 7 (From Host) |

► Getting start to Syslog capture

Syslog capture is another way to obtain syslog which the same as remote syslog server and filelog. The capture file is saved as pcap format so that it can be opened in some of capture software like Wireshark, Ethereal software etc.

► To enable syslog capture

- ◆ Select Syslog special only on Network Capture page

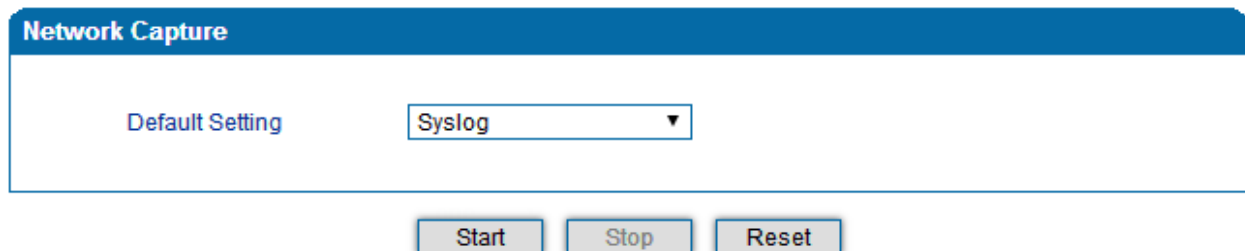

- ◆ Click “Start’ to enable syslog capture
- ◆ Dialing out through gateway, start talking a short while then hangup the call.
- ◆ Click ‘Stop’ to disable syslog capture
- ◆ Save the capture to local computer

The capture is named to ‘capture(x).pcap’, x is serial number of capture and will be added 1 in next time. The sample of syslog capture as below:

| No. | Time | Source | Destination | Protocol | Length | Info |
|-----|----------|---------------|-------------|----------|--------|--|
| 1 | 0.000000 | 172.16.222.22 | 1.1.1.1 | Syslog | 172 | USER.DEBUG: Jul 23 06:52:05 172.16.222.22 mpe_sip: < 0> [DEBUG] ---> to 172.16.222.22/5060 crypt:FALSE Phone |
| 2 | 0.000344 | 172.16.222.22 | 1.1.1.1 | Syslog | 520 | USER.DEBUG: Jul 23 06:52:05 172.16.222.22 mpe_sip: < 1> [DEBUG] OPTIONS sip:heartbeat@172.16.222.22 SIP/2.0\r\n |
| 3 | 0.013432 | 172.16.222.22 | 1.1.1.1 | Syslog | 595 | USER.DEBUG: Jul 23 06:52:05 172.16.222.22 mpe_sip: < 2> [DEBUG] <<<<<<*** message from 172.16.222.22/5060, crypt |
| 4 | 0.013750 | 172.16.222.22 | 1.1.1.1 | Syslog | 176 | USER.DEBUG: Jul 23 06:52:05 172.16.222.22 mpe_sip: < 3> [DEBUG] <<<<<< from 172.16.222.22/5060, crypt:FALSE, Phc |
| 5 | 0.014036 | 172.16.222.22 | 1.1.1.1 | Syslog | 520 | USER.DEBUG: Jul 23 06:52:05 172.16.222.22 mpe_sip: < 4> [DEBUG] OPTIONS sip:heartbeat@172.16.222.22 SIP/2.0\r\n |
| 6 | 0.014512 | 172.16.222.22 | 1.1.1.1 | Syslog | 172 | USER.DEBUG: Jul 23 06:52:05 172.16.222.22 mpe_sip: < 5> [DEBUG] ---> to 172.16.222.22/5060 crypt:FALSE Phone |
| 7 | 0.014806 | 172.16.222.22 | 1.1.1.1 | Syslog | 587 | USER.DEBUG: Jul 23 06:52:05 172.16.222.22 mpe_sip: < 6> [DEBUG] SIP/2.0 200 OK\r\nvia: SIP/2.0/UDP 172.16.222. |
| 8 | 0.028396 | 172.16.222.22 | 1.1.1.1 | Syslog | 662 | USER.DEBUG: Jul 23 06:52:05 172.16.222.22 mpe_sip: < 7> [DEBUG] <<<<<<*** message from 172.16.222.22/5060, crypt |
| 9 | 0.028759 | 172.16.222.22 | 1.1.1.1 | Syslog | 176 | USER.DEBUG: Jul 23 06:52:05 172.16.222.22 mpe_sip: < 8> [DEBUG] <<<<<< from 172.16.222.22/5060, crypt:FALSE, Phc |
| 10 | 0.029052 | 172.16.222.22 | 1.1.1.1 | Syslog | 587 | USER.DEBUG: Jul 23 06:52:05 172.16.222.22 mpe_sip: < 9> [DEBUG] SIP/2.0 200 OK\r\nvia: SIP/2.0/UDP 172.16.222. |
| 11 | 0.030017 | 172.16.222.22 | 1.1.1.1 | Syslog | 233 | USER.DEBUG: Jul 23 06:52:05 172.16.222.22 mpe_sip: < 10> [DEBUG] sip-->app: msgtype:ST_SIP_SERVER_DOWN \r\n cal |
| 12 | 0.331167 | 172.16.222.22 | 1.1.1.1 | Syslog | 983 | USER.DEBUG: Jul 23 06:52:05 172.16.222.22 mpe_sip: < 11> [DEBUG] <<<<<<*** message from 172.16.222.127/5060, cryp |
| 13 | 0.331498 | 172.16.222.22 | 1.1.1.1 | Syslog | 177 | USER.DEBUG: Jul 23 06:52:05 172.16.222.22 mpe_sip: < 12> [DEBUG] <<<<<< from 172.16.222.127/5060, crypt:FALSE, Pf |
| 14 | 0.331959 | 172.16.222.22 | 1.1.1.1 | Syslog | 907 | USER.DEBUG: Jul 23 06:52:05 172.16.222.22 mpe_sip: < 13> [DEBUG] INVITE sip:10086@172.16.222.22:5060 SIP/2.0\r\n |
| 15 | 0.332307 | 172.16.222.22 | 1.1.1.1 | Syslog | 122 | USER.DEBUG: Jul 23 06:52:05 172.16.222.22 mpe_ecc: < 14> [DEBUG] get route entry 31\r\n |
| 16 | 0.332584 | 172.16.222.22 | 1.1.1.1 | Syslog | 111 | USER.DEBUG: Jul 23 06:52:05 172.16.222.22 mpe_ecc: < 15> [DEBUG] !Port:3\r\n |
| 17 | 0.332848 | 172.16.222.22 | 1.1.1.1 | Syslog | 124 | USER.DEBUG: Jul 23 06:52:05 172.16.222.22 mpe_ecc: < 16> [DEBUG] get route, to port:3\r\n |
| 18 | 0.333315 | 172.16.222.22 | 1.1.1.1 | Syslog | 526 | USER.DEBUG: Jul 23 06:52:05 172.16.222.22 mpe_sip: < 17> [DEBUG] sip-->app: localindex:69, msgtype:SIP_CALL_INV |
| 19 | 0.333603 | 172.16.222.22 | 1.1.1.1 | Syslog | 173 | USER.DEBUG: Jul 23 06:52:05 172.16.222.22 mpe_sip: < 18> [DEBUG] ---> to 172.16.222.127/5060 crypt:FALSE Phone |
| 20 | 0.333877 | 172.16.222.22 | 1.1.1.1 | Syslog | 386 | USER.DEBUG: Jul 23 06:52:05 172.16.222.22 mpe_sip: < 19> [DEBUG] SIP/2.0 100 Trying\r\nvia: SIP/2.0/UDP 172.16. |
| 21 | 0.346687 | 172.16.222.22 | 1.1.1.1 | Syslog | 131 | USER.DEBUG: Jul 23 06:52:05 172.16.222.22 mpe_ecc: < 20> [DEBUG] RTP: alg:0, pkt:20, band:1\r\n |
| 22 | 0.347453 | 172.16.222.22 | 1.1.1.1 | Syslog | 120 | USER.DEBUG: Jul 23 06:52:05 172.16.222.22 mpe_ecc: < 21> [DEBUG] dial tick:102433\r\n |
| 23 | 7.232839 | 172.16.222.22 | 1.1.1.1 | Syslog | 533 | USER.DEBUG: Jul 23 06:52:12 172.16.222.22 mpe_sip: < 22> [DEBUG] <<<<<<*** message from 172.16.222.127/5060, cryp |
| 24 | 7.233513 | 172.16.222.22 | 1.1.1.1 | Syslog | 177 | USER.DEBUG: Jul 23 06:52:12 172.16.222.22 mpe_sip: < 23> [DEBUG] <<<<<< from 172.16.222.127/5060, crypt:FALSE, Pf |
| 25 | 7.233959 | 172.16.222.22 | 1.1.1.1 | Syslog | 457 | USER.DEBUG: Jul 23 06:52:12 172.16.222.22 mpe_sip: < 24> [DEBUG] CANCEL sip:10086@172.16.222.22:5060 SIP/2.0\r\n |
| 26 | 7.234596 | 172.16.222.22 | 1.1.1.1 | Syslog | 287 | USER.DEBUG: Jul 23 06:52:12 172.16.222.22 mpe_sip: < 25> [DEBUG] sip-->app: localindex:69, msgtype:SIP_CALL_BYE |

▶ Getting start to RTP capture

PCM capture is help to analysis voice stream between gateway and remote IPPBX/SIP Server.

▶ To enable RTP capture:

- ◆ Select RTP special on Network Capture page

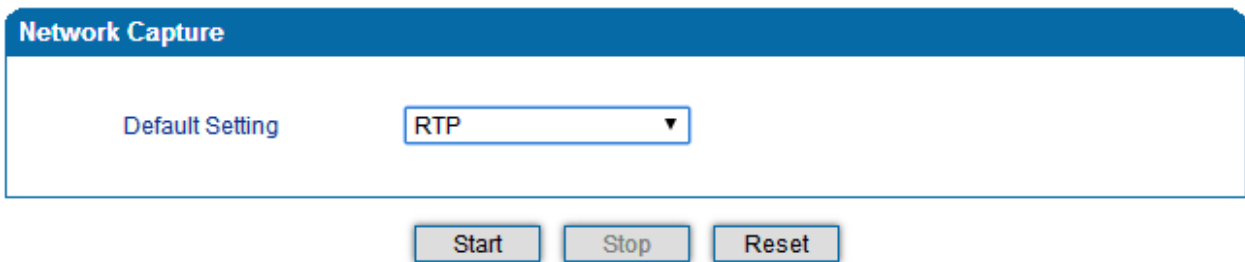

- ◆ Click Start to enable RTP capture
- ◆ Dialing out through gateway, start talking a short while then hangup the call.
- ◆ Click Stop to disable RTP capture
- ◆ Save the capture to local computer

The capture is named to 'capture(x).pcap', x is serial number of capture and will be added 1 in next time. The sample of RTP capture as below:

| No. | Time | Source | Destination | Protocol | Length | Info |
|-----|-----------|----------------|----------------|----------|--------|---|
| 176 | 7.020000 | 172.16.221.228 | 116.204.105.50 | SIP | 565 | Request: REGISTER sip:116.204.105.50 |
| 178 | 7.030000 | 116.204.105.50 | 172.16.221.228 | SIP | 411 | Status: 200 OK (1 bindings) |
| 244 | 11.610000 | 172.16.221.228 | 58.56.64.101 | SIP/SDP | 814 | Request: INVITE sip:201@58.56.64.101 |
| 248 | 11.710000 | 58.56.64.101 | 172.16.221.228 | SIP | 480 | Status: 100 Trying |
| 249 | 11.710000 | 58.56.64.101 | 172.16.221.228 | SIP/SDP | 733 | Status: 183 Session Progress |
| 250 | 11.710000 | 58.56.64.101 | 172.16.221.228 | SIP/SDP | 719 | Status: 200 OK |
| 252 | 11.720000 | 172.16.221.228 | 58.56.64.101 | RTP | 66 | Unknown RTP version 1 |
| 253 | 11.720000 | 172.16.221.228 | 58.56.64.101 | RTP | 66 | Unknown RTP version 1 |
| 254 | 11.720000 | 58.56.64.101 | 172.16.221.228 | RTP | 74 | PT=ITU-T G.729, SSRC=0x497E6D15, Seq=1000, Time=160, Mark |
| 255 | 11.720000 | 172.16.221.228 | 58.56.64.101 | RTP | 66 | Unknown RTP version 1 |
| 256 | 11.730000 | 172.16.221.228 | 58.56.64.101 | RTP | 66 | Unknown RTP version 1 |
| 257 | 11.730000 | 172.16.221.228 | 58.56.64.101 | RTP | 66 | Unknown RTP version 1 |
| 258 | 11.740000 | 172.16.221.228 | 58.56.64.101 | SIP | 434 | Request: ACK sip:201@58.56.64.101:5060 |
| 259 | 11.740000 | 58.56.64.101 | 172.16.221.228 | RTP | 74 | PT=ITU-T G.729, SSRC=0x497E6D15, Seq=1001, Time=320 |
| 261 | 11.770000 | 58.56.64.101 | 172.16.221.228 | RTP | 74 | PT=ITU-T G.729, SSRC=0x497E6D15, Seq=1002, Time=480 |
| 263 | 11.780000 | 58.56.64.101 | 172.16.221.228 | RTP | 74 | PT=ITU-T G.729, SSRC=0x497E6D15, Seq=1003, Time=640 |
| 264 | 11.810000 | 58.56.64.101 | 172.16.221.228 | RTP | 74 | PT=ITU-T G.729, SSRC=0x497E6D15, Seq=1004, Time=800 |
| 265 | 11.830000 | 58.56.64.101 | 172.16.221.228 | RTP | 74 | PT=ITU-T G.729, SSRC=0x497E6D15, Seq=1005, Time=960 |
| 266 | 11.840000 | 58.56.64.101 | 172.16.221.228 | RTP | 74 | PT=ITU-T G.729, SSRC=0x497E6D15, Seq=1006, Time=1120 |
| 267 | 11.870000 | 58.56.64.101 | 172.16.221.228 | RTP | 74 | PT=ITU-T G.729, SSRC=0x497E6D15, Seq=1007, Time=1280 |
| 268 | 11.890000 | 58.56.64.101 | 172.16.221.228 | RTP | 74 | PT=ITU-T G.729, SSRC=0x497E6D15, Seq=1008, Time=1440 |
| 270 | 11.900000 | 58.56.64.101 | 172.16.221.228 | RTP | 74 | PT=ITU-T G.729, SSRC=0x497E6D15, Seq=1009, Time=1600 |
| 271 | 11.930000 | 172.16.221.228 | 58.56.64.101 | RTP | 74 | PT=ITU-T G.729, SSRC=0x43455AA6, Seq=31521, Time=1806312883 |
| 273 | 11.930000 | 58.56.64.101 | 172.16.221.228 | RTP | 74 | PT=ITU-T G.729, SSRC=0x497E6D15, Seq=1010, Time=1760 |
| 274 | 11.940000 | 58.56.64.101 | 172.16.221.228 | RTP | 74 | PT=ITU-T G.729, SSRC=0x497E6D15, Seq=1011, Time=1920 |
| 275 | 11.950000 | 172.16.221.228 | 58.56.64.101 | RTP | 74 | PT=ITU-T G.729, SSRC=0x43455AA6, Seq=31522, Time=1806313043 |
| 277 | 11.970000 | 58.56.64.101 | 172.16.221.228 | RTP | 74 | PT=ITU-T G.729, SSRC=0x497E6D15, Seq=1012, Time=2080 |
| 278 | 11.970000 | 172.16.221.228 | 58.56.64.101 | RTP | 74 | PT=ITU-T G.729, SSRC=0x43455AA6, Seq=31523, Time=1806313203 |

► Getting start to DSP capture

DSP capture is help to analysis voice stream inside DSP chipset. The DSP chipset will handle RTP from IP network as well as voice stream from analog phone.

► To enable DSP capture:

- ◆ Select DSP only on Network Capture page

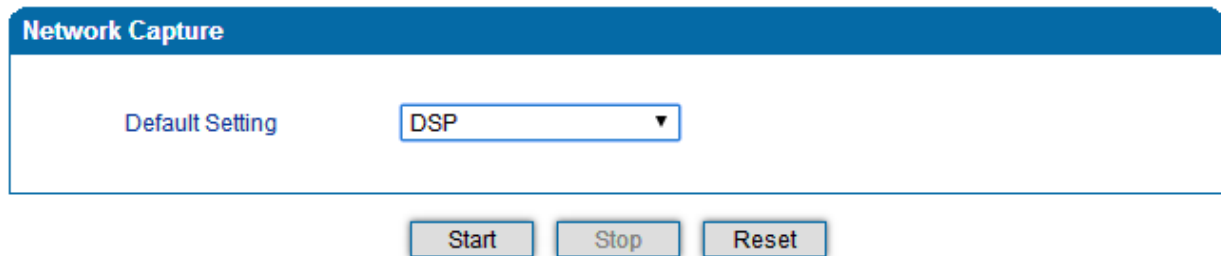

- ◆ Click Start to enable DSP capture
- ◆ Dialing out through gateway, start talking a short while then hangup the call.
- ◆ Click Stop to disable DSP capture
- ◆ Save the capture to local computer

The capture is named to 'capture(x).pcap', x is serial number of capture and will be added 1 in next time. The sample of RTP capture as below:

| No. | Time | Source | Destination | Protocol | Length | Info | |
|-----|----------|-------------------|-------------------|------------|--------|-------------------------------|--------------------------------|
| 1 | 0.000000 | Motorola_1c:1d:1e | Cimsys_33:44:55 | CSM_ENCABS | 104 | --> 0x0021 | Ch: 0xFFFF, Seq: 2 (From Host) |
| 2 | 0.007246 | Cimsys_33:44:55 | Motorola_1c:1d:1e | Ethernet | 20 | Ethernet II[Malformed Packet] | |
| 3 | 0.007260 | Cimsys_33:44:55 | Motorola_1c:1d:1e | CSM_ENCABS | 44 | --> 0x0021 | Ch: 0xFFFF, Seq: 5 (From Host) |
| 4 | 2.994581 | Motorola_1c:1d:1e | Cimsys_33:44:55 | CSM_ENCABS | 104 | --> 0x0021 | Ch: 0xFFFF, Seq: 3 (From Host) |
| 5 | 2.997308 | Cimsys_33:44:55 | Motorola_1c:1d:1e | Ethernet | 20 | Ethernet II[Malformed Packet] | |
| 6 | 2.997316 | Cimsys_33:44:55 | Motorola_1c:1d:1e | CSM_ENCABS | 44 | --> 0x0021 | Ch: 0xFFFF, Seq: 6 (From Host) |
| 7 | 5.992790 | Motorola_1c:1d:1e | Cimsys_33:44:55 | CSM_ENCABS | 104 | --> 0x0021 | Ch: 0xFFFF, Seq: 4 (From Host) |
| 8 | 5.997282 | Cimsys_33:44:55 | Motorola_1c:1d:1e | Ethernet | 20 | Ethernet II[Malformed Packet] | |
| 9 | 5.997290 | Cimsys_33:44:55 | Motorola_1c:1d:1e | CSM_ENCABS | 44 | --> 0x0021 | Ch: 0xFFFF, Seq: 7 (From Host) |
| 10 | 7.691428 | Motorola_1c:1d:1e | Cimsys_33:44:55 | CSM_ENCABS | 104 | --> 0x9010 | Ch: 0x0003, Seq: 3 (From Host) |
| 11 | 7.691552 | Cimsys_33:44:55 | Motorola_1c:1d:1e | Ethernet | 20 | Ethernet II[Malformed Packet] | |
| 12 | 7.691715 | Cimsys_33:44:55 | Motorola_1c:1d:1e | CSM_ENCABS | 30 | <-- 0x9010 | Ch: 0x0003, Seq: 1 (To Host) |
| 13 | 7.701379 | Motorola_1c:1d:1e | Cimsys_33:44:55 | CSM_ENCABS | 104 | --> 0x9000 | Ch: 0x0003, Seq: 4 (From Host) |
| 14 | 7.701494 | Cimsys_33:44:55 | Motorola_1c:1d:1e | Ethernet | 20 | Ethernet II[Malformed Packet] | |
| 15 | 7.701622 | Cimsys_33:44:55 | Motorola_1c:1d:1e | CSM_ENCABS | 30 | <-- 0x9000 | Ch: 0x0003, Seq: 2 (To Host) |
| 16 | 7.709662 | Motorola_1c:1d:1e | Cimsys_33:44:55 | CSM_ENCABS | 104 | --> 0x8084 | Ch: 0x0003, Seq: 5 (From Host) |
| 17 | 7.709798 | Cimsys_33:44:55 | Motorola_1c:1d:1e | Ethernet | 20 | Ethernet II[Malformed Packet] | |
| 18 | 7.709902 | Cimsys_33:44:55 | Motorola_1c:1d:1e | CSM_ENCABS | 30 | <-- 0x8084 | Ch: 0x0003, Seq: 3 (To Host) |
| 19 | 7.710238 | Motorola_1c:1d:1e | Cimsys_33:44:55 | CSM_ENCABS | 104 | --> 0x8001 | Ch: 0x0003, Seq: 6 (From Host) |
| 20 | 7.710328 | Cimsys_33:44:55 | Motorola_1c:1d:1e | Ethernet | 20 | Ethernet II[Malformed Packet] | |
| 21 | 7.710496 | Cimsys_33:44:55 | Motorola_1c:1d:1e | CSM_ENCABS | 30 | <-- 0x8001 | Ch: 0x0003, Seq: 4 (To Host) |
| 22 | 7.716241 | Motorola_1c:1d:1e | Cimsys_33:44:55 | CSM_ENCABS | 104 | --> 0x8018 | Ch: 0x0003, Seq: 7 (From Host) |
| 23 | 7.716352 | Cimsys_33:44:55 | Motorola_1c:1d:1e | Ethernet | 20 | Ethernet II[Malformed Packet] | |
| 24 | 7.716465 | Cimsys_33:44:55 | Motorola_1c:1d:1e | CSM_ENCABS | 30 | <-- 0x8018 | Ch: 0x0003, Seq: 5 (To Host) |
| 25 | 7.716711 | Motorola_1c:1d:1e | Cimsys_33:44:55 | CSM_ENCABS | 104 | --> 0x805b | Ch: 0x0003, Seq: 8 (From Host) |

► **Configurable capture options**

► **Getting start to custom capture**

This menu provides more options to capture specific packets according to actually needs.

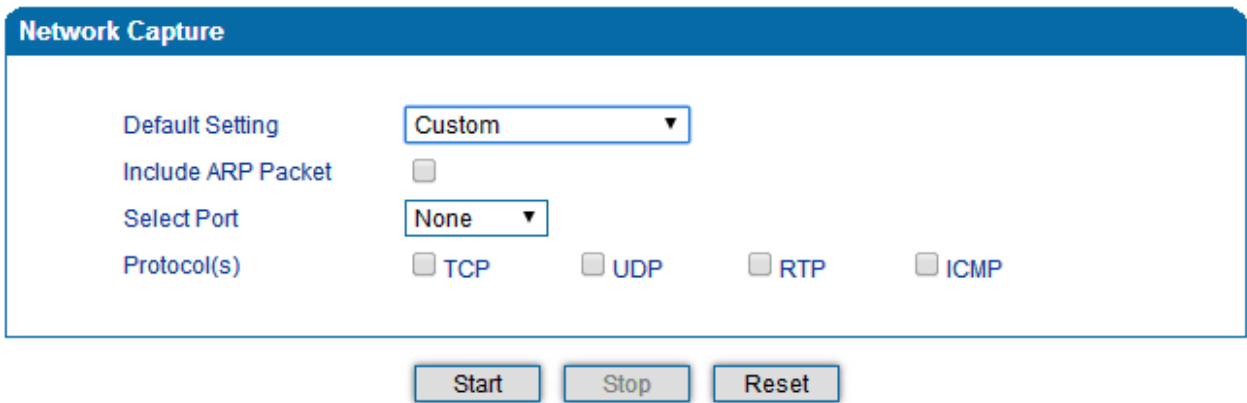

3.16.8 Factory Reset

Click 'Apply' to restore the factory settings.

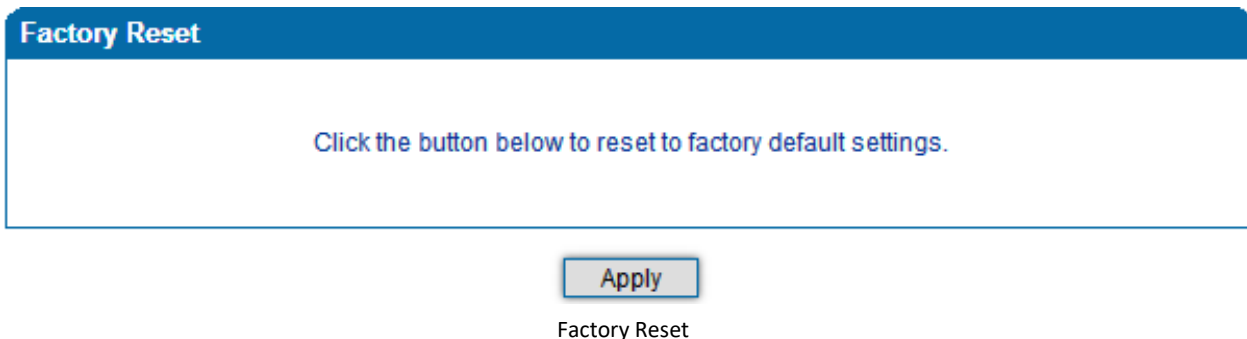

3.16.9 Device Restart

After saving all the configurations or changes to the equipment, user can restart the DAG1000-8S gateway for the changes to take effect.



Restart

Restart Gateway

4 Glossary

- DNS: Domain Name System
- SIP: Session Initiation Protocol
- TCP: Transmission Control Protocol
- UDP: User Datagram Protocol
- RTP: Real Time Protocol
- PPPOE: point-to-point protocol over Ethernet
- VLAN: Virtual Local Area Network
- ARP: Address Resolution Protocol
- CID: Caller Identity
- DND: Do NOT Disturb
- DTMF: Dual Tone Multi Frequency
- NTP: Network Time Protocol
- DMZ: Demilitarized Zone
- STUN: Simple Traversal of UDP over NAT
- PSTN: Public Switched Telephone Network
- IMS: IP Multimedia Subsystem
- ACL: access rule list
- SNMP: Simple Network Management Protocol
- FXS: Foreign Exchange Station
- FXO: Foreign Exchange Office